

This range of self-compensating shock absorbers is part of the innovative **MAGNUM Series** from ACE. You profit from the enhanced product life in the most difficult operating environments provided by the latest seal technology, hardened main bearing and also the integrated positive stop. You achieve **50% more Energy absorption capacity** and a much wider range of effective weight capability (**between 3 kg and 63 700 kg!**). This offers you the capability of mounting shock absorbers with the highest energy capacity ratings for their size in the Industry and allows full exploitation of your machinery potential. You can access new possibilities in machine design and construction since this range offers such features as a fully threaded outer body and a new clamping flange system.

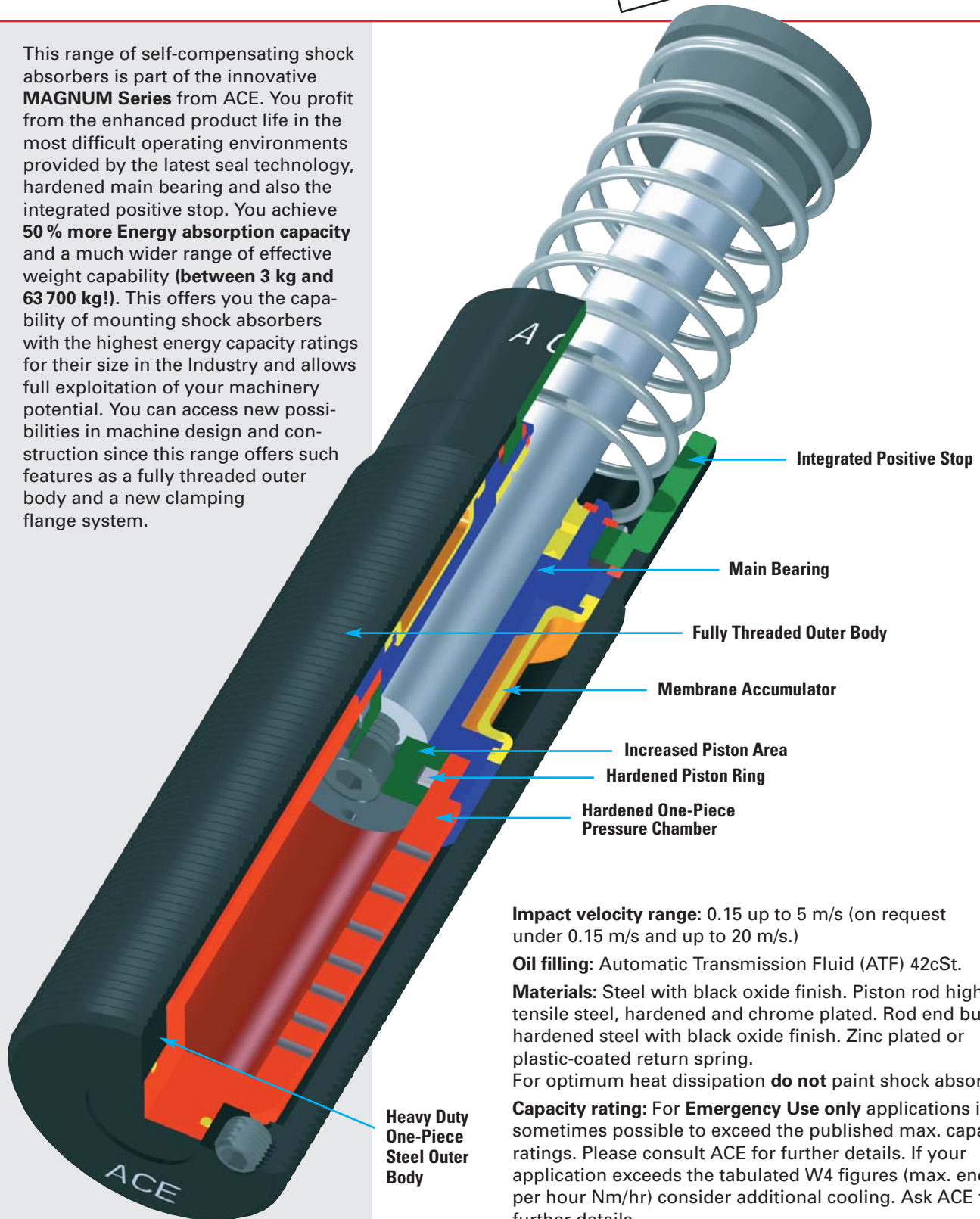

Impact velocity range: 0.15 up to 5 m/s (on request under 0.15 m/s and up to 20 m/s.)

Oil filling: Automatic Transmission Fluid (ATF) 42cSt.

Materials: Steel with black oxide finish. Piston rod high tensile steel, hardened and chrome plated. Rod end button hardened steel with black oxide finish. Zinc plated or plastic-coated return spring.

For optimum heat dissipation **do not** paint shock absorber.

Capacity rating: For **Emergency Use only** applications it is sometimes possible to exceed the published max. capacity ratings. Please consult ACE for further details. If your application exceeds the tabulated W4 figures (max. energy per hour Nm/hr) consider additional cooling. Ask ACE for further details.

Mounting: In any position.

Temperature range: -12°C to 70°C. For higher temperatures consult ACE.

On request: plated finishes. Weartec finish (seawater resistant), special oils. Mounting inside air cylinders and other special options are available on request.



This adjustable shock absorber from ACE is unique. The innovative **MAGNUM Series** models provide the next generation of deceleration technology to meet the needs of the future. The latest seal technology, a hardened main bearing and the integrated positive stop provide a significant increase in operating lifetime. Other innovations such as the front and rear adjuster, new clamping flanges and the fully threaded outer body provide many new options in installation and mounting. Exploit the advantages of this series in your applications with its **50% increased energy capacity** and a much wider effective weight range. The effective weight range extends from 9 kg up to 80 000 kg. **The MA range** models cover the majority of standard applications, whilst **the ML range** is specially designed for low velocity/high effective weight applications from 300 kg up to 500 000 kg effective weight.

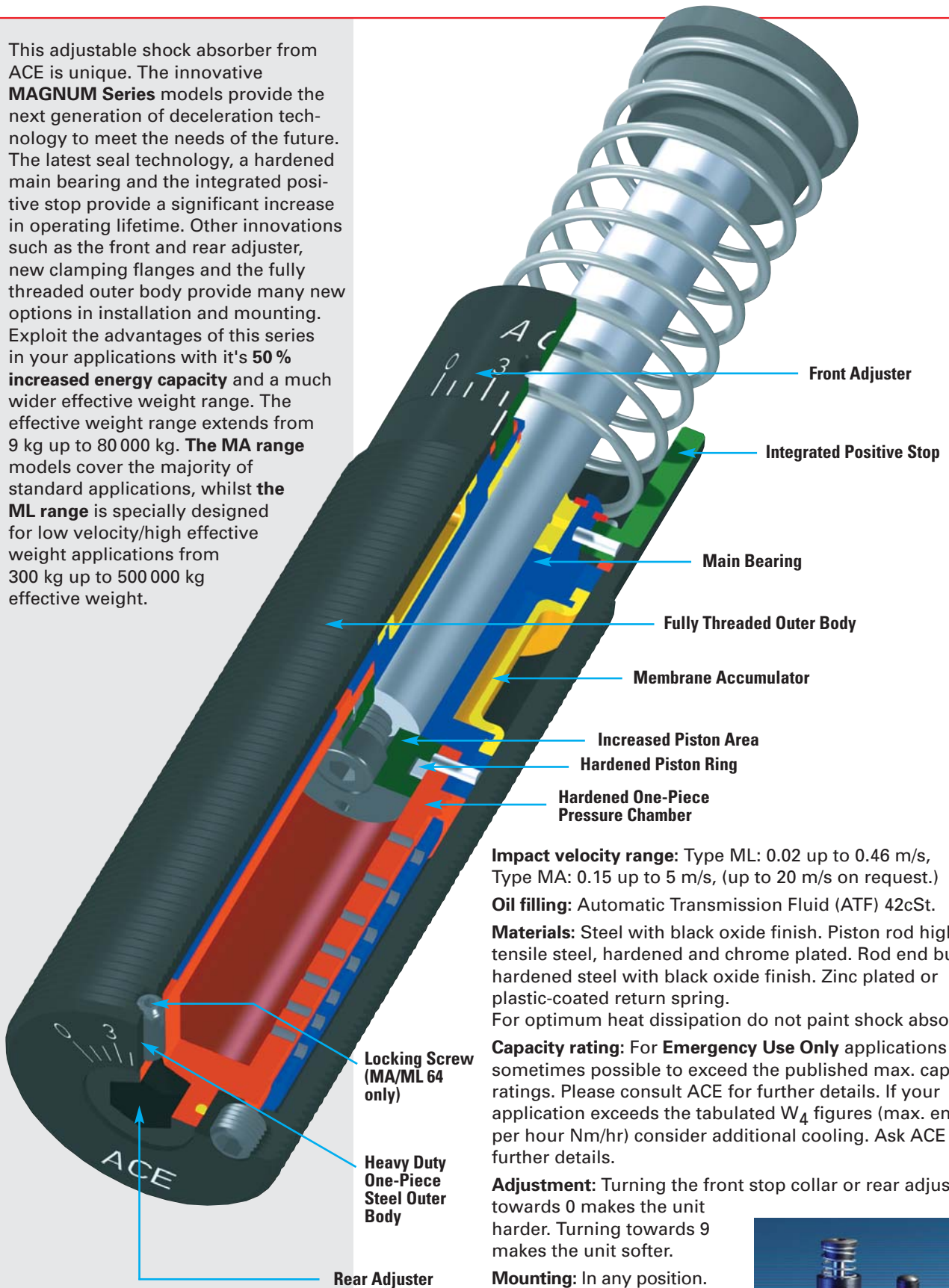

Impact velocity range: Type ML: 0.02 up to 0.46 m/s, Type MA: 0.15 up to 5 m/s, (up to 20 m/s on request.)

Oil filling: Automatic Transmission Fluid (ATF) 42cSt.

Materials: Steel with black oxide finish. Piston rod high tensile steel, hardened and chrome plated. Rod end button hardened steel with black oxide finish. Zinc plated or plastic-coated return spring.

For optimum heat dissipation do not paint shock absorber.

Capacity rating: For **Emergency Use Only** applications it is sometimes possible to exceed the published max. capacity ratings. Please consult ACE for further details. If your application exceeds the tabulated W_4 figures (max. energy per hour Nm/hr) consider additional cooling. Ask ACE for further details.

Adjustment: Turning the front stop collar or rear adjuster towards 0 makes the unit harder. Turning towards 9 makes the unit softer.

Mounting: In any position.

Temperature range: -12°C to +70°C. For higher temperatures consult ACE.

On request: plated finishes. Weartec finish (seawater resistant), special oils. Mounting inside air cylinders and other special options are available on request.



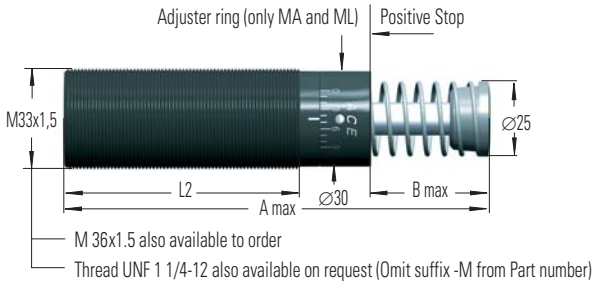

Square Flange and Foot mountings do not require the use of a Locking Ring for installation (new slotted clamping system).

S 33

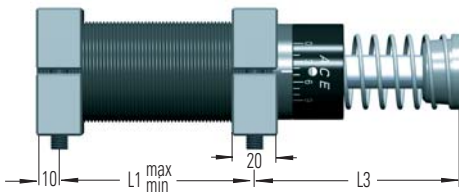

Because of the thread pitch the fixing holes for the second foot mount should only be drilled and tapped after the first foot mount has been fixed in position.

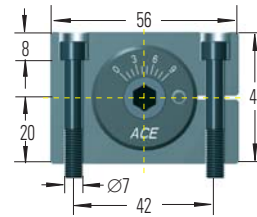

Side Foot Mounting Kit

S 33 = 2 Flanges + 4 Screws M6x40, DIN 912

Tightening torque 11 Nm
Clamping torque > 90 Nm

C 33

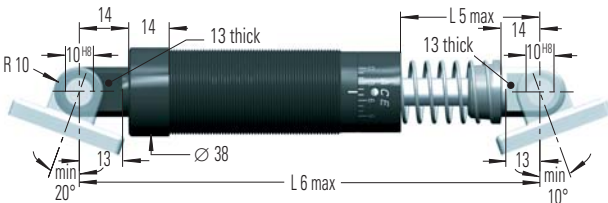

Clevis Mounting Kit

C 33 = 2 Clevis eyes. Delivered assembled to shock absorber.
Use positive stop at both ends of travel

SF 33

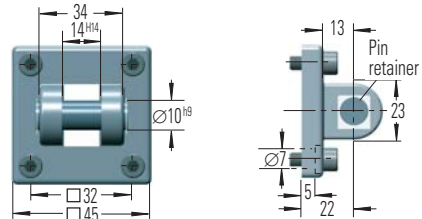

Clevis Flange

SF 33 = Flange + 4 screws M6x20 DIN 912
Tightening torque 7.5 Nm
Conforms to: Audi + VW 39D1307/2/032, VDMA 24562 part 2
Daimler Chr. B801520023647, Opel-GM M13911673

Secure with pin or use additional bar.

Dimensions

Type	*Stroke	A max	B max	L1 min	L1 max	L2	L3	L5 max	L6 max
MC, MA, ML 3325 M	25	138	23	25	60	83	68	39	168
MC, MA, ML 3350 M	50	189	48.5	32	86	108	93	64	218

* Nominal stroke length (without integral stop collar fitted).

Capacity Chart

Type	**per Cycle	Max. Energy Capacity Nm			Soft *Effective Weight me					Return Force N	Rod Reset Time s	Max. Side Load Angle °	Max. Weight kg
		Self-contained	With air/oil tank	With oil recirculation	-0 min kg max	-1 min kg max	-2 min kg max	-3 min kg max	-4 min kg max				
MC 3325 M	155	75 000	124 000	169 000	3 - 11	9 - 40	30 - 120	100 - 420	350 - 1 420	45 - 90	0.03	4	0.45
MC 3350 M	310	85 000	135 000	180 000	5 - 22	18 - 70	60 - 250	210 - 840	710 - 2 830	45 - 135	0.06	3	0.54

Type	Adjustable	**per Cycle	Self-contained	With air/oil tank	With oil recirculation	*Effective Weight me		Return Force N	Rod Reset Time s	Max. Side Load Angle °	Max. Weight kg
						Type MA min kg max	Type ML min kg max				
MA, ML 3325 M	170	75 000	124 000	169 000	9 - 1700	300 - 50 000	45 - 90	0.03	4	0.45	
MA, ML 3350 M	340	85 000	135 000	180 000	13 - 2 500	500 - 80 000	45 - 135	0.06	3	0.54	

* The effective weight range limits can be raised or lowered to special order.

** For **Emergency Use Only** applications it is sometimes possible to exceed the above ratings. Please consult ACE for further details. Specifications relate to the effective stroke length (B max.).

M33x1.5 For use on new installations:

NM 33

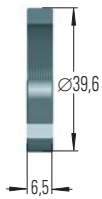

Locking Ring

PP 33

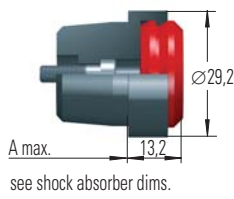

Poly Button

Optional button with elastomer insert for noise suppression. Option supplied ready mounted onto the shock absorber. For self installation see mounting instructions on page 48.

QF 33

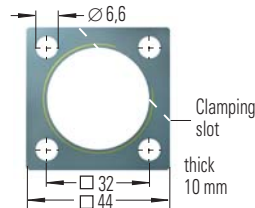

Square Flange

Install with 4 machine screws with tightening torque: = 11 Nm
Clamping torque: > 90 Nm

BV 3325 BV 3350

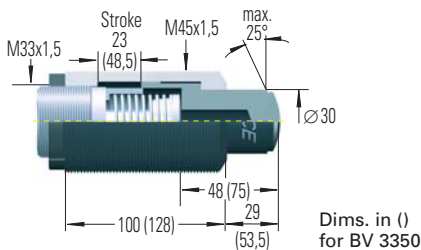

Side Load Adaptor

Mounting, installation etc. see pages 35 and 45.

Dims. in ()
for BV 3350

AS 33

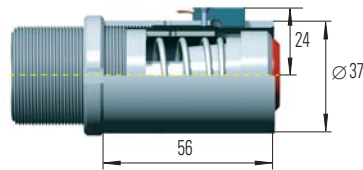

Switch Stop Collar
inc. Proximity Switch and Poly Button with elastomer insert

PB 3325 PB 3350

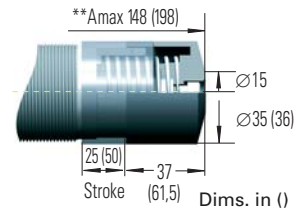

Steel Shroud

**Total installation length of the shock absorber inc. steel shroud

Ordering Example

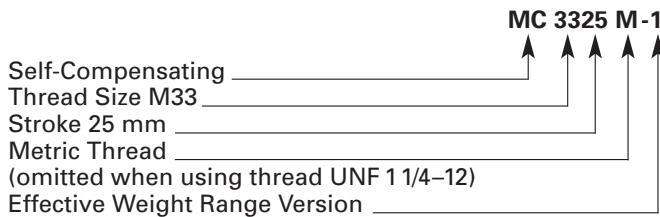

Model Type Prefix

Standard Models

Self-Contained with Return Spring

- MC self-compensating
- MA adjustable
- ML adjustable, for lower impact velocity

Special Models

Air/Oil Return without Return Spring

- MCA, MAA, MLA

Air/Oil Return with Return Spring

- MCS, MAS, MLS

Self-Contained without Return Spring

- MCN, MAN, MLN

Interchange Parts for the earlier Types MC 120...

C 1200

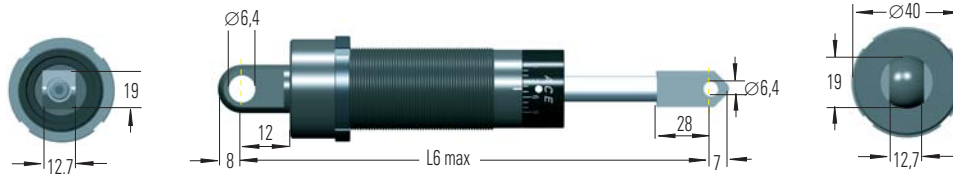

Clevis Mounting (Use positive stop at both ends of travel)

Clevis Mounting Kit C 1200 (250-0323) = 1 Rear clevis flange + 1 Rod clevis + 1 Locking ring (supplied assembled to shock absorber).

RFL 1200

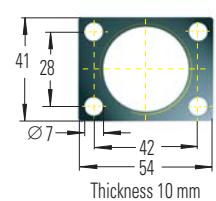

Rectangular Flange

Locking ring also required

S 1200

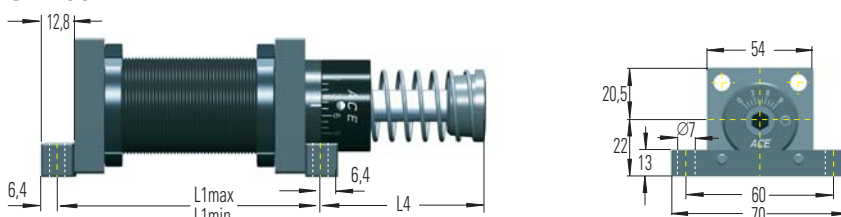

Side Foot Mounting

Foot Mounting Kit S 1200 (250-0294) = 2 Rectangular flanges + 2 Side bars + 2 Locking rings + 4 Socket head screws.

Dimensions

Stroke	L ₁ *	L ₄	L ₆ max.
25	97	47.4	167
50	122	73.4	218

* Dimension can be altered.

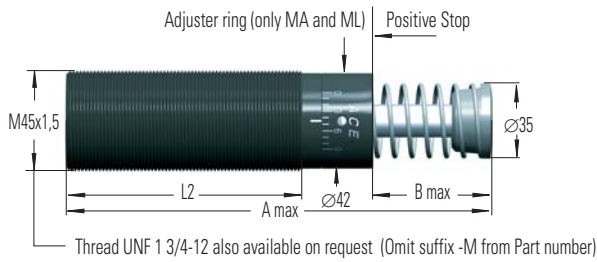

Adjuster (only MA and ML)

S 45

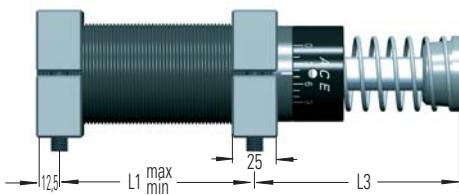

Because of the thread pitch the fixing holes for the second foot mount should only be drilled and tapped after the first foot mount has been fixed in position.

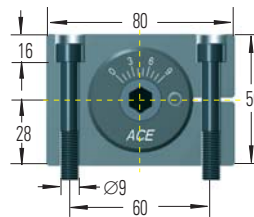

Side Foot Mounting Kit

S 45 = 2 Flanges + 4 Screws M 8x50, DIN 912

Tightening torque 27 Nm
Clamping torque > 350 Nm

C 45

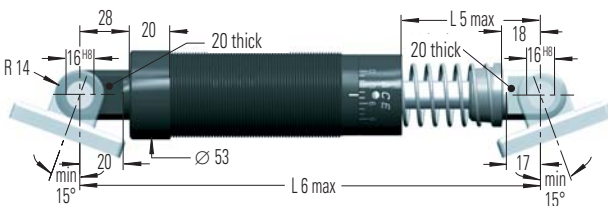

Clevis Mounting Kit

C 45 = 2 Clevis eyes. Delivered assembled to shock absorber. Use positive stop at both ends of travel

SF 45

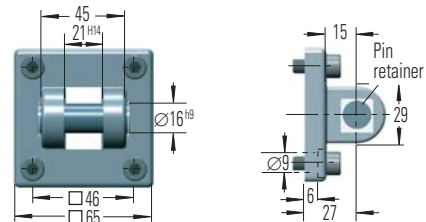

Clevis Flange

SF 45 = Flange + 4 screws M 8x20 DIN 912
Tightening torque 7.5 Nm
Conforms to: Audi + VW 39D1307/2/050, VDMA 24562 part 2
Daimler Chr. B801520023647, Opel-GM M13911675

Secure with pin or use additional bar.

Dimensions

Type	*Stroke	A max	B max	L1 min	L1 max	L2	L3	L5 max	L6 max
MC, MA, ML 4525 M	25	145	23	32	66	95	66	43	200
MC, MA, ML 4550 M	50	195	48.5	40	92	120	91	68	250
MC, MA 4575 M	75	246	74	50	118	145	116	93	300

* Nominal stroke length (without integral stop collar fitted).

Capacity Chart

Type	**per Cycle Self-Compensating W ₃	Max. Energy Capacity Nm		* Effective Weight me					Return Force N min max	Rod Reset Time s	Max. Side Load Angle °	Max. Weight kg	
		Self-Contained W ₄	per Hour with Air/Oil Tank	Soft -0 min kg max	-1 min kg max	-2 min kg max	-3 min kg max	-4 min kg max					
MC 4525 M	340	107 000	158 000	192 000	7 - 27	20 - 90	80 - 310	260 - 1 050	890 - 3 540	70 - 100	0.03	4	1.13
MC 4550 M	680	112 000	192 000	248 000	13 - 54	45 - 180	150 - 620	520 - 2 090	1 800 - 7 100	70 - 145	0.08	3	1.36
MC 4575 M	1 020	146 000	225 000	282 000	20 - 80	70 - 270	230 - 930	790 - 3 140	2 650 - 10 600	50 - 180	0.11	2	1.59
Type Adjustable					* Effective Weight me								
MA, ML 4525 M	390	107 000	158 000	192 000	Type MA min kg max		Type ML min kg max			70 - 100	0.03	4	1.13
MA, ML 4550 M	780	112 000	192 000	248 000	70 - 14 500		3 000 - 110 000			70 - 145	0.08	3	1.36
MA 4575 M	1 170	146 000	225 000	282 000	70 - 15 000		5 000 - 180 000			50 - 180	0.11	2	1.59

* The effective weight range limits can be raised or lowered to special order.

** For **Emergency Use Only** applications it is sometimes possible to exceed the above ratings. Please consult ACE for further details. Specifications relate to the effective stroke length (B max.).

M45x1.5 For use on new installations:

NM 45

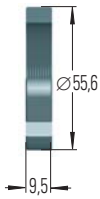

Locking Ring

PP 45

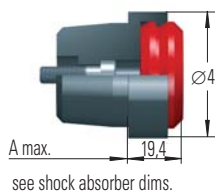

Poly Button

Optional button with elastomer insert for noise suppression. Option supplied ready mounted onto the shock absorber. For self installation see mounting instructions on page 48.

QF 45

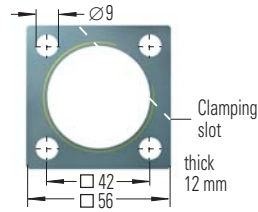

Square Flange

Install with 4 machine screws with tightening torque: = 27 Nm
Clamping torque: > 200 Nm

BV 4525 BV 4550

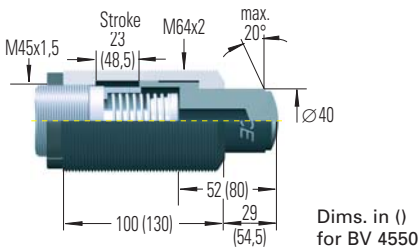

Side Load Adaptor

Mounting, installation etc. see pages 35 and 45.

Dims. in ()
for BV 4550

AS 45

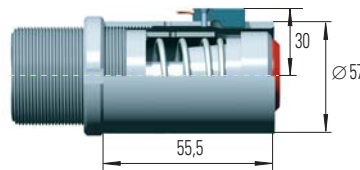

Switch Stop Collar
inc. Proximity Switch and Poly Button with elastomer insert

PB 4525 PB 4550

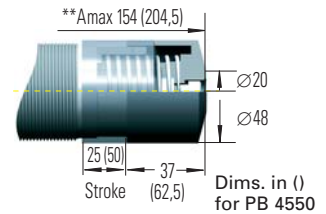

Steel Shroud

** Total installation length of the shock absorber inc. steel shroud

Ordering Example

Adjustable _____
Thread Size M45 _____
Stroke 25 mm _____
Metric Thread _____
(omitted when using thread UNF 13/4-12)

ML 4525 M

Model Type Prefix

Standard Models

Self-Contained with Return Spring

- MC self-compensating
- MA adjustable
- ML adjustable, for lower impact velocity

Special Models

Air/Oil Return without Return Spring

MCA, MAA, MLA

Air/Oil Return with Return Spring

MCS, MAS, MLS

Self-Contained without Return Spring

MCN, MAN, MLN

Interchange Parts for the earlier Types MC 140...

C 1400

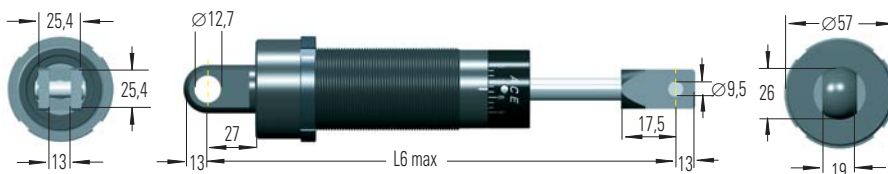

RFL 1400

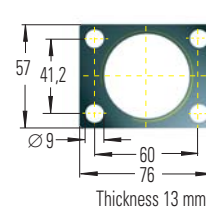

Rectangular Flange

Locking ring also required

QFL 1400

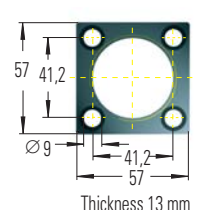

Square Flange

Locking ring also required

S 1400

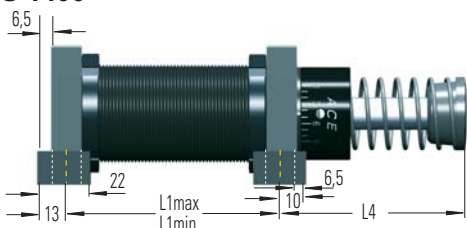

Side Foot Mounting

Foot Mounting Kit S 1400 (250-0300) = 2 Square flanges + 2 Side bars + 2 Locking rings + 4 Socket head screws.

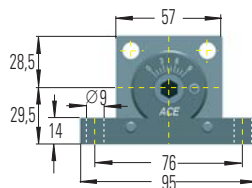

Dimensions

Stroke	L ₁ *	L ₄	L ₆ max.
25	89	49.5	200
50	111	77.5	250
75	136	103.5	301

* Dimension can be altered.

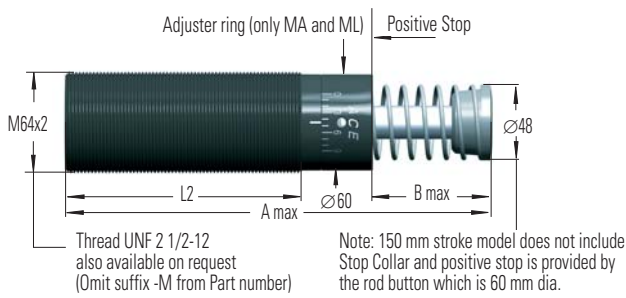

Adjuster (only MA and ML)

S 64

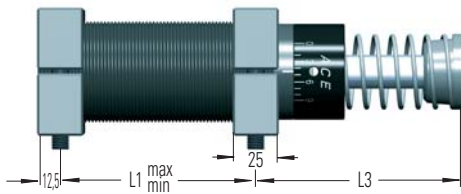

Because of the thread pitch the fixing holes for the second foot mount should only be drilled and tapped after the first foot mount has been fixed in position.

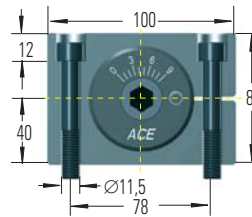

Side Foot Mounting Kit

S 64 = 2 Flanges + 4 Screws M10x80, DIN 912

Tightening torque 50 Nm
Clamping torque > 350 Nm

C 64

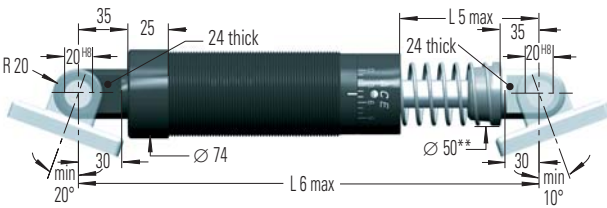

Clevis Mounting Kit

C 64 = 2 Clevis eyes. Delivered assembled to shock absorber.
** with 150 mm stroke Dia. 60 mm. Order C 64/150.
Use positive stop at both ends of travel

SF 64

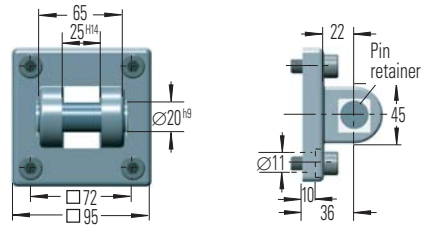

Clevis Flange

SF 64 = Flange + 4 Screws M 10x20 DIN 912
Tightening torque 15 Nm
Conforms to: Audi + VW 39D1307/2/050, VDMA 24562 part 2
Daimler Chr. B801520023647, Opel-GM M13911675

Secure with pin or use additional bar.

Dimensions

Type	*Stroke	A max	B max	L1 min	L1 max	L2	L3	L5 max	L6 max
ML 6425 M	25	174	23	40	86	114	75.5	60	260
MC, MA, ML 6450 M	50	225	48.5	50	112	140	100	85	310
MC, MA 64100 M	100	326	99.5	64	162	191	152	136	410
MC, MA 64150 M	150	450	150	80	212	241	226	187	530

* Nominal stroke length (without integral stop collar fitted).

Capacity Chart

Type	**per Cycle W ₃	Max. Energy Capacity Nm		*Effective Weight me					Return Force N	Rod Reset Time s	Max. Side Load Angle °	Max. Weight kg	
		Self-Contained	W ₄ per Hour with Air/Oil Tank	Soft	-0	-1	-2	-3					-4
MC 6450 M	1 700	146 000	293 000	384 000	35 - 140	140 - 540	460 - 1 850	1 600 - 6 300	5 300 - 21 200	90 - 155	0.12	4	2.90
MC 64100 M	3 400	192 000	384 000	497 000	70 - 280	270 - 1 100	930 - 3 700	3 150 - 12 600	10 600 - 42 500	105 - 270	0.34	3	3.70
MC 64150 M	5 100	248 000	497 000	644 000	100 - 460	410 - 1 640	1 390 - 5 600	4 700 - 18 800	16 000 - 63 700	75 - 365	0.48	2	5.10

Type	Adjustable	*Effective Weight me		Type MA min kg max	Type ML min kg max	Return Force N	Rod Reset Time s	Max. Side Load Angle °	Max. Weight kg
		min kg max	min kg max						
ML 6425 M	1 020	124 000	248 000	332 000	7 000 - 300 000	120 - 155	0.06	5	2.50
MA, ML 6450 M	2 040	146 000	293 000	384 000	11 000 - 500 000	90 - 155	0.12	4	2.90
MA 64100 M	4 080	192 000	384 000	497 000		105 - 270	0.34	3	3.70
MA 64150 M	6 120	248 000	497 000	644 000		75 - 365	0.48	2	5.10

* The effective weight range limits can be raised or lowered to special order.

** For **Emergency Use Only** applications it is sometimes possible to exceed the above ratings. Please consult ACE for further details. Specifications relate to the effective stroke length (B max.).

M64x2 For use on new installations:

NM 64

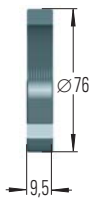

Locking Ring

PP 64

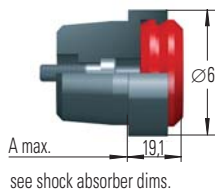

Poly Button

Optional button with elastomer insert for noise suppression. Option supplied ready mounted onto the shock absorber. For self installation see mounting instructions on page 48.

QF 64

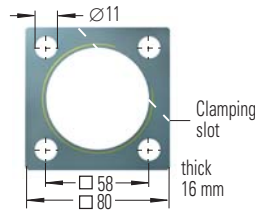

Square Flange

Install with 4 machine screws with tightening torque: = 50 Nm
Clamping torque: > 210 Nm

BV 6425 BV 6450

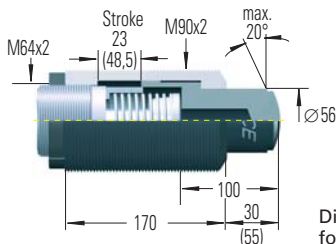

Side Load Adaptor

Mounting, installation etc. see page 45.

Dims. in ()
for BV 6450

QF 90

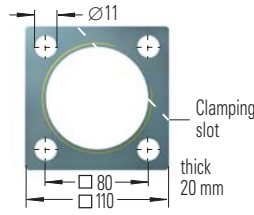

Square Flange

Install with 4 machine screws with tightening torque: = 50 Nm
Clamping torque: > 210 Nm

PB 6425 PB 6450

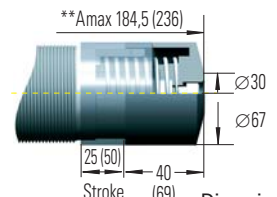

Steel Shroud

** Total installation length of the shock absorber inc. steel shroud

Ordering Example

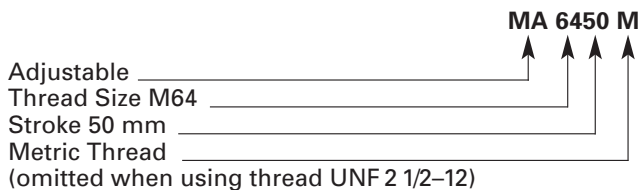

Model Type Prefix

Standard Models

Self-Contained with Return Spring

- MC self-compensating
- MA adjustable
- ML adjustable, for lower impact velocity

Special Models

Air/Oil Return without Return Spring

MCA, MAA, MLA

Air/Oil Return with Return Spring

MCS, MAS, MLS

Self-Contained without Return Spring

MCN, MAN, MLN

Interchange Parts for the earlier Types MC 160...

C 1600

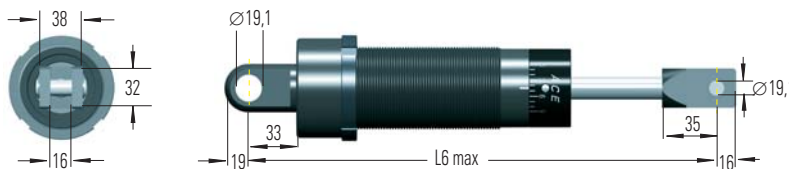

Clevis Mounting (Use positive stop at both ends of travel)

Clevis Mounting Kit C 1600 (250-0327) = 1 Rear clevis flange + 1 Rod clevis + 1 Locking ring (supplied assembled to shock absorber). Locking ring also required

QFL 1600

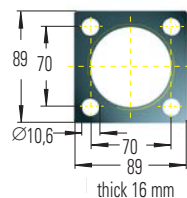

Square Flange

S 1600

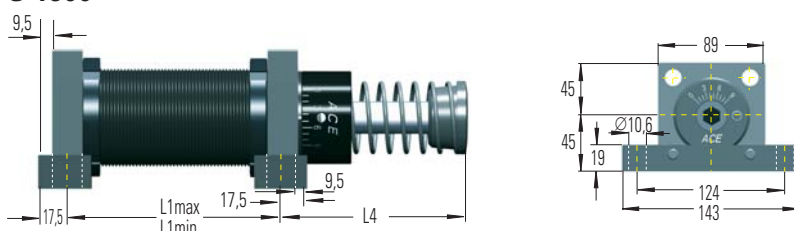

Side Foot Mounting

Foot Mounting Kit S 1600 (250-0303) = 2 Square flanges + 2 Side bars + 2 Locking rings + 4 Socket head screws.

Dimensions

Stroke	L ₁ *	L ₄	L ₆ max.
25	102	64	257
50	127	90	309
100	178	140	410
150	229	214	530

* Dimension can be altered.

* Earlier Model

* Earlier Model				MAGNUM Series					
Code	Adjustable	*W ₃	Stroke mm	Adjustable	*W ₃	Stroke mm	Self-Compensating	*W ₃	Stroke mm
1	A 1 1/2x2 ...	1800	50	MA 6450 M ...	2040	50	MC 6450 M ...	1700	50
2	A 1 1/2x3 1/2 ...	3200	89	MA 64100 M...	4080	100	MC 64100 M ...	3400	100
3	A 1 1/2x5 ...	4500	127	MA 64100 M ...	4080	100	MC 64100 M ...	3400	100
4	A 1 1/2x6 1/2 ...	5900	165	MA 64150 M ...	6120	150	MC 64150 M ...	5100	150

* W₃ = Max. energy capacity per cycle in Nm.

44

A 1 1/2 x ...-R (Rear Flange)

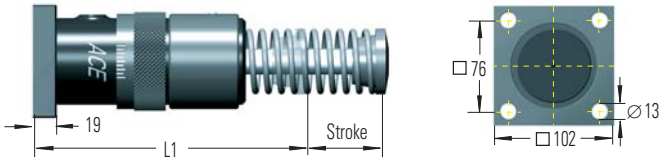

MA 64 ..., MC 64 ...



Dimensions

Code	L1
1	196
2	233
3	271
4	329

Flange QFR 64-1 1/2

A 1 1/2 x ...-F (Front Flange)

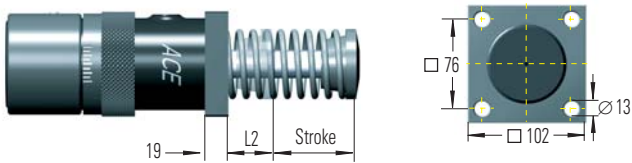

MA 64 ..., MC 64 ...

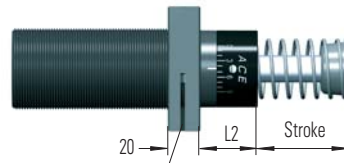

Dimensions

Code	L2
1	55
2	54
3	54
4	73

Flange QFF 64-1 1/2

A 1 1/2 x ...-S (Side Foot Mounting)

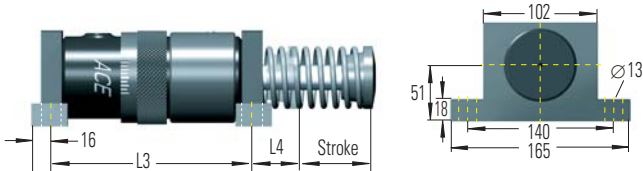

MA 64 ..., MC 64 ...

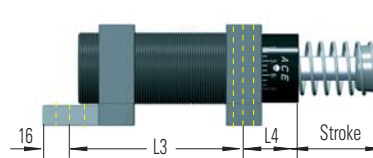

Dimensions

Code	L3	L4
2	170	59
3	208	59
4	246	78

Foot Mount Set S 64-1 1/2

A 1 1/2 x ...-S (Side Foot Mounting)

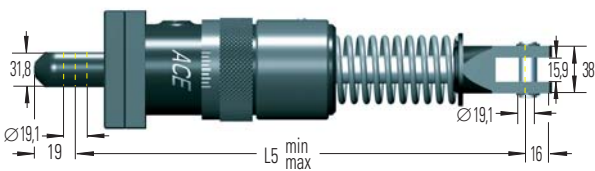

MA 64 ..., MC 64 ...



Clevis Mount Set C 64-1 1/2

Dimensions

Code	L5 min	*A1 1/2 L5 max	*MA 64 L5 max
1	278.0	328.6	328.0
2	317.0	405.6	417.0
3	353.0	481.8	453.0
4	412.0	577.0	562.0

* Note! L5 max. is not the same.

BV... Side Load Adaptor

For side load impact angles from 3° to 25°.

With side load impact angles of more than 3° the operating lifetime of the shock absorber reduces rapidly due to increased wear of the rod bearings. The optional BV side load adaptor provides a long lasting solution. For mounting the adaptor has the same outer thread as the next larger size of standard shock absorber i.e.:

BV 3325 (M45x1.5) for MC, MA, ML 3325 M (M33x1.5)

BV 3350 (M45x1.5) for MC, MA, ML 3350 M (M33x1.5)

BV 4525 (M64x2) for MC, MA, ML 4525 M (M45x1.5)

BV 4550 (M64x2) for MC, MA, ML 4550 M (M45x1.5)

BV 6425 (M90x2) for ML 6425 M (M64x2)

BV 6450 (M90x2) for MC, MA, ML 6450 M (M64x2)

Material: Threaded body and plunger hardened high tensile steel.

Mounting: Directly mount the shock absorber on the outside thread of the side load adaptor or by using the QF flange. You cannot use a foot mounting.

Calculation example see page 34.

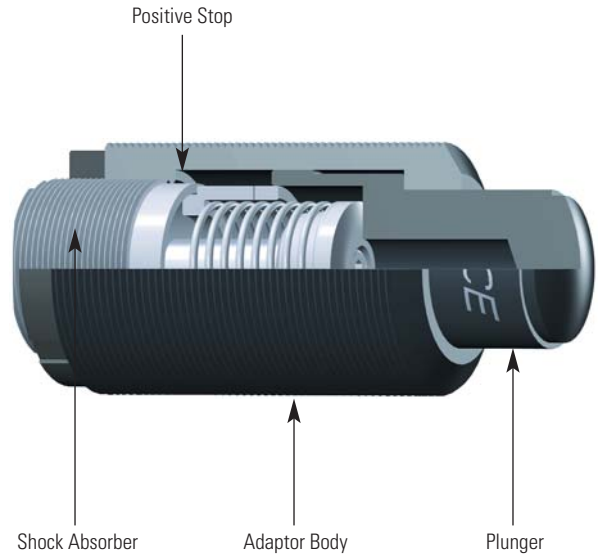

PB... Steel Shroud

For thread sizes M33x1.5, M45x1.5 and M64x2 with 25 mm or 50 mm stroke.

Grinding beads, sand, welding splatter, paints and adhesives etc. can adhere to the piston rod. They then damage the rod seals and the shock absorber quickly fails. In many cases the installation of the optional Steel Shroud can provide worthwhile protection and increase lifetime.

Material: Hardened high tensile steel.

Mounting: To mount the PB steel shroud it is necessary to remove the rod end button of the shock absorber.

Note!

When installing don't forget to allow operating space for the shroud to move as the shock absorber is cycled.

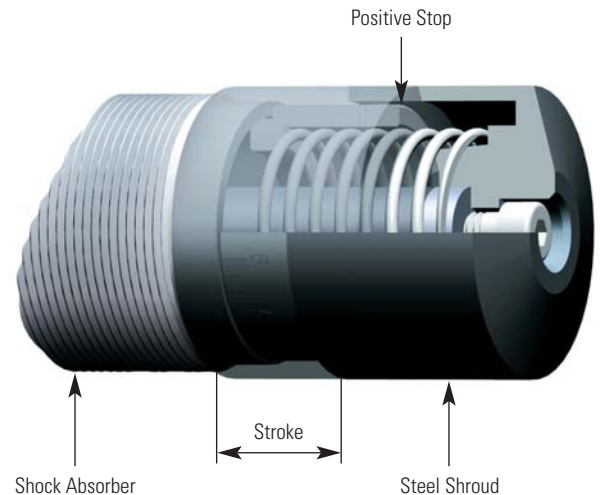

AS... Switch Stop Collar

For thread sizes M33x1.5 and M45x1.5

The new ACE StopLight Switch Stop Collar combination serves as a safety element to provide stroke position information for automatically sequenced machines. The compact construction allows its use in nearly any application. The standard rod button is detected by the proximity switch at the end of its stroke to provide switch actuation. The switch is normally open when the shock absorber is extended and only closes when it has completed its operating stroke.

The AS Switch Stop Collar combination is only delivered ready mounted onto the shock absorber c/w the switch.

Material: Hardened high tensile steel.

For circuit diagram of proximity switch see page 35.

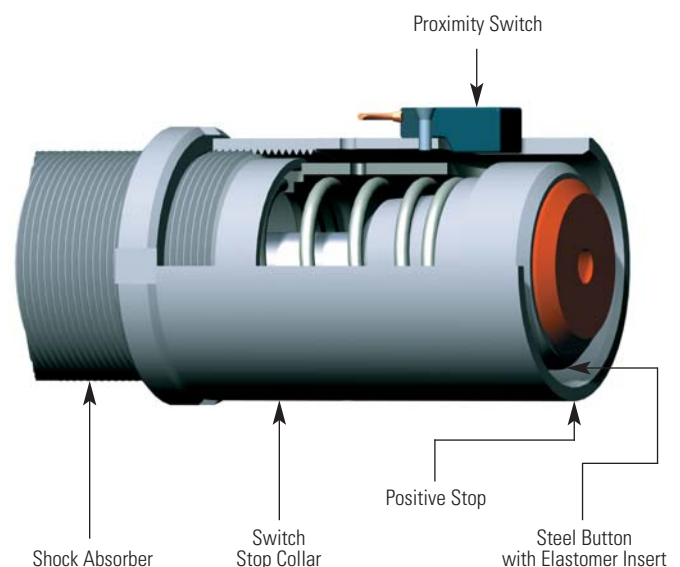

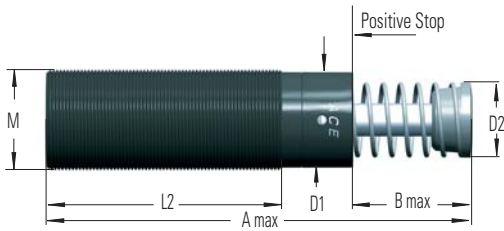

Dimensions and Capacity Chart

Max. Energy Capacity

Model Part Number	*Stroke mm	A max	B	D1	D2	L2	M	Nm per cycle		Nm per hour		Max. Side Load Angle °	Weight kg
								W ₃ max. Nm	W ₄ max. Nm	at 20°C W ₄ max. Nm	at 100°C W ₄ max. Nm		
MC 3325 M	25	138	23	30	25	83	M33x1.5	155	215 000	82 000	4	0.45	
MC 3350 M	50	189	48.5	30	25	108	M33x1.5	310	244 000	93 000	3	0.54	
MC 4525 M	25	145	23	42	35	95	M45x1.5	340	307 000	117 000	4	1.13	
MC 4550 M	50	195	48.5	42	35	120	M45x1.5	680	321 000	122 000	3	1.36	
MC 4575 M	75	246	74	42	35	145	M45x1.5	1 020	419 000	159 000	2	1.59	
MC 6450 M	50	225	48.5	60	48	140	M64x2	1 700	419 000	159 000	4	2.90	
MC 64100 M	100	326	99.5	60	48	191	M64x2	3 400	550 000	200 000	3	3.70	

*nominal stroke length (without stop collar fitted)

The Calculation and Selection of the most suitable shock absorber (effective weight range) for your application should be carried out or checked by ACE Controls. Adjustable models are also available on request.

Ordering Example

MC 3350 M-2-HT

Self-Compensating _____
 Thread Size M33 _____
 Stroke 50 mm _____
 Metric Thread (omitted when using thread UNF) _____
 Effective Weight Range Code _____
 Version for High Temperature Use _____

Details Required when Ordering:

Load to be Decelerated m (kg)
 Impact Velocity v (m/s)
 Propelling Force F (N)
 Operating Cycles per Hour x (/hr)
 Number of Absorbers in Parallel n
 Ambient Temperature °C

Technical Data

Impact velocity range: 0.15 to 5 m/s, up to 20 m/s on request.

Oil filling: special temperature stable synthetic oil.

Material: Shock absorber body and accessories: Steel with black oxide finish. Piston rod: high tensile steel hardened and chrome plated. Rod end button: hardened steel with black oxide finish. Zinc plated return spring. For optimum heat dissipation **do not** paint shock absorber.

Mounting: in any position.

Operating temperature range: -20°C to 150°C.

Capacity rating: For **Emergency Use Only** applications it is sometimes possible to exceed the published max. capacity ratings. Please consult ACE for further details. If your application exceeds the tabulated W₄ figures (max. energy per hour Nm/hr) consider additional cooling. Ask ACE for further details.

On request: Plated finishes for additional corrosion protection.



AO 1

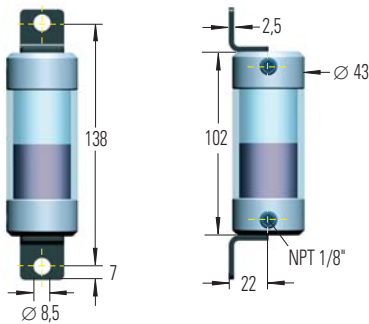

Oil capacity 20 cm³
Material: Alu. caps and polycarbonate body.

AO 3

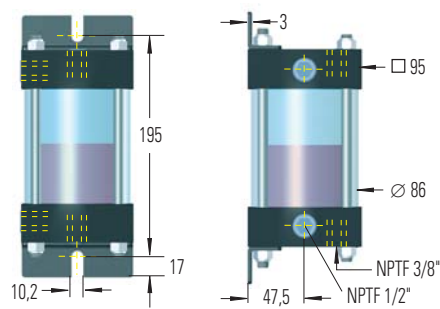

Oil capacity 330 cm³
Material: Alu. caps and steel body polycarbonate sight gauge.

AO 691

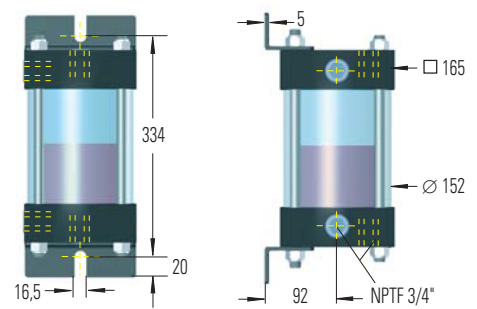

Oil capacity 2600 cm³
Material: Alu. caps and steel body polycarbonate sight gauge.

Max. pressure 8 bar. Max. temperature 80°C.

Oil filling: ATF-Oil 42 cSt at 40°C for all shock absorbers in Magnum Series.
Mount air/oil tank higher than shock absorber. Bleed all air from system before operating.

Attention: Exhaust tank before carrying out service. Check valve holds pressure!

Part Numbers

Type	with tank	examples 1-4	with tank	examples 5-6	Conn. pipe. Ø min.
MCA, MAA, MLA 33...	AO 1	CV 1/8	AO 3	CV 1/4	4
MCA, MAA, MLA 45...	AO 1	CV 1/8	AO 3	CV 3/8	6
MCA, MAA, MLA 64...	AO 3	CV 1/4	AO 691	CV 1/2	8
CAA, AA 2...	AO 691	CV 1/2	AO 82	CV 3/4	15
CAA, AA 3...	AO 691	CV 1/2	AO 82	CV 3/4	19
CAA 4...	AO 82	CV 3/4	AO 82	CV 3/4	38

AO 82 details on request.

Suggested Air/Oil tanks in accordance with W₄ ratings

Connection Examples Air/Oil Tanks

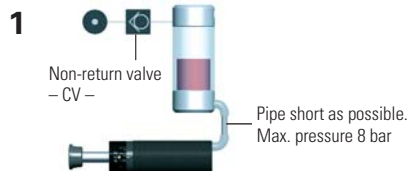

Piston rod returns immediately to extended position when load moves away. Operation without main air supply possible for short periods.

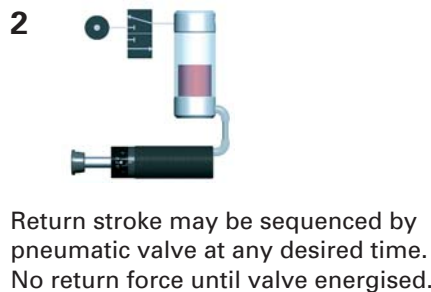

Return stroke may be sequenced by pneumatic valve at any desired time. No return force until valve energised.

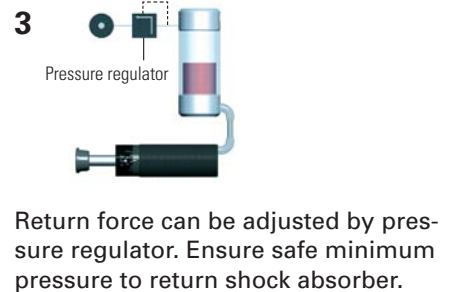

Return force can be adjusted by pressure regulator. Ensure safe minimum pressure to return shock absorber.



Spring return with Air/Oil Tank. No air supply connected. Note: Will extend return time.

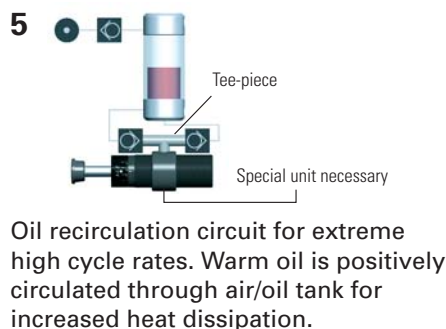

Oil recirculation circuit for extreme high cycle rates. Warm oil is positively circulated through air/oil tank for increased heat dissipation.

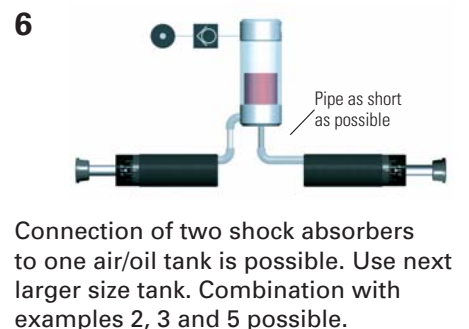

Connection of two shock absorbers to one air/oil tank is possible. Use next larger size tank. Combination with examples 2, 3 and 5 possible.

Thread Sizes for connection to air/oil tank

Type	Thread bottom	Thread side**
MCA, MAA, MLA 33	G 1/8 inside*	G 1/8 inside
MCA, MAA, MLA 45	G 1/8 inside	G 1/8 inside
MCA, MAA, MLA 64	G 1/4 inside	G 1/4 inside

* adapted
** on request (add suffix -PG/-P)

Part Numbers CV...
max. pressure 20 bar
max. temperature 95°C
Suitable for: Oil, Air, Water.
Material: Aluminium

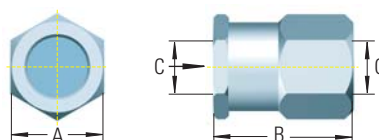

Model

Part No.	A	B	C
CV 1/8	19	24	1/8
CV 1/4	29	33	1/4
CV 3/8	29	33	3/8
CV 1/2	41	40	1/2
CV 3/4	48	59	3/4

Mechanical Stop

The MAGNUM Series units have a built in stop collar (mechanical stop) which also serves as the front adjuster.

If using a shock absorber without a stop collar it is important to install a mechanical stop 0.5 to 1 mm before the end of the stroke.



Stop Collar + Front Adjuster*



Rear Adjuster*

*MA and ML only

48

General

For optimum heat dissipation do not paint the shock absorber. For applications in environments with acids, dusts or powders, abrasives, steam or water please protect the shock absorber and/or consider the special accessories on page 45. The shock absorber should be securely mounted onto a flat and smooth surface of adequate strength.

Self Compensating Models

The MC family of shock absorbers are self compensating. Providing the effective weight on the application remains within the band given in the capacity charts then no adjustment is necessary for changes in weights, speeds or propelling force. These units are available with five standard operating bands (me min. – me max.) and are identified by the suffix number after the model which goes from -0 (very soft) up to -4 (very hard).

The optimum deceleration is achieved when there is no abrupt change in the load velocity at the beginning or the end of the shock absorber stroke.

If there is a hard impact at the start of stroke → use the next softer version (i.e. lower suffix number).

If there is a hard setdown at the end of stroke → use the next harder version, or mount two units in parallel.

Alternatively change to a larger bore size unit. Contact ACE for further advice.

Adjustable Models

The adjustment has a graduated scale from 0 to 9. The adjuster in the body of MA/ML 64 has a side mounted locking screw which should be loosened (1/2 turn max.) with a hex. key before commencing adjustment. The MAGNUM Series units can be adjusted by the hex. socket at the rear of the body – or by rotating the front stop collar. Both adjusters are internally connected and will show the same adjustment value on the scales as they are turned. After installation cycle the equipment a few times and turn the adjustment until optimum deceleration is achieved (i.e. no abrupt change in the load velocity observed at the beginning or at the end of shock absorber stroke). The shock absorber is delivered set at 5.

If there is a hard impact at start of stroke → adjust the unit softer i.e. towards 9 on the scale.

If there is a hard setdown at end of stroke → adjust the unit harder i.e. towards 0.

Adjustment approaching "0" means: a) Impact velocity is too low: consider changing to Model type ML or:

- b) Shock absorber selected is too small: use next larger size or mount 2 units in parallel.

Mounting Options

Basic Model



Flange Mounting



Side Foot Mounting



Clevis Mounting



Removing Rod End Button

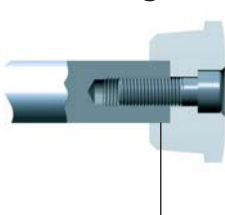

Press fit (screw loctited for security).

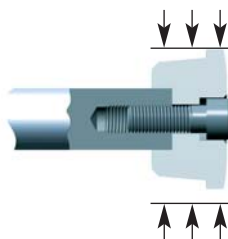

Clamp button in vice and loosen screw 3 or 4 turns.

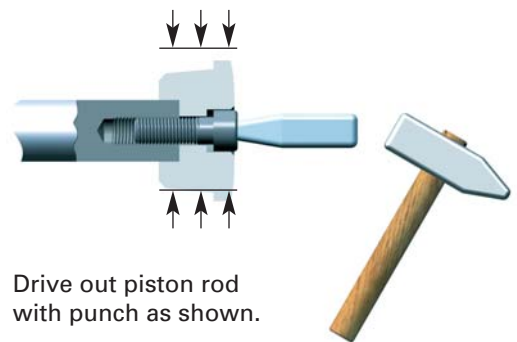

Drive out piston rod with punch as shown.

Repairs

It is possible to overhaul ACE shock absorbers in M33 sizes and larger. We would recommend that damaged or worn shock absorbers are returned to ACE for repair. You will find that this is more economic than the comparative cost of repairing yourself. Spare parts and seal kits etc. are available however if required.