

HYDAC INTERNATIONAL

Hydraulic Accumulators in Hybrid Technology.



HYDAC

Your Competent Partner for Innovative Accumulators and Hybrid Systems.

All the requirements for efficient accumulator solutions.

With over 6,500 employees worldwide, HYDAC is one of the leading suppliers for fluid technology, hydraulic and electronic equipment.

Our wide range of products, combined with expertise in development, manufacturing, sales and service, has for decades enabled the most diverse challenges in hydraulic energy storage and recovery to be overcome, in almost all sectors of the industry.

Global and yet local.

With over 45 overseas companies, and more than 500 sales and service partners, HYDAC is within easy reach of its customers and is a reliable partner worldwide.

System solutions. One supplier. One contact.

Wherever you need us, we are there to help you find the most effective solution – for almost every application, from components to a complete system.

Worldwide specifications and approvals.

Having authorization for accumulators of all types in all industrial countries, HYDAC can provide its customers with trouble-free certification and the greatest operating safety.



HYDAC Headquarters Germany



HYDAC China



HYDAC Japan



HYDAC Korea



HYDAC USA



HYDAC France



HYDAC India

Energy Storage Devices Compared.

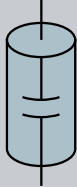
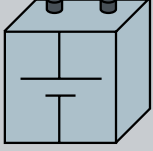
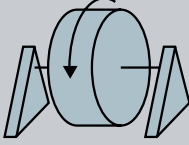
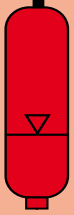
Technology	Electrical		Mechanical	Hydraulic
Energy storage device	Double layer capacitor 	Lithium ion battery 	Flywheel 	Hydraulic accumulator 
Energy density	-	+	o	-
Power density	+	o	o	+
Ageing / Capacity loss	o	-	o	+
Temperature sensitivity	-	-	o	+
Self discharge	-	o	-	+
Packaging	o	o	o	o
Cost effectiveness	-	o	o	+

Hybrid Technology.

Hybrid drives for vehicles or machines have at least two energy sources.

The main energy source is usually a combustion engine (diesel, petrol, gas) or an electric motor connected to the mains supply.

The secondary energy source in hybrid systems can be either electrical batteries, double-layer capacitors, flywheel systems or hydraulic accumulators designed for intermediate energy storage.

Even if energy recovery is not absolutely necessary for the drive, making full use of all the advantages of hybrid technology makes for compelling saving potentials.

Using hydraulic accumulators and intelligent system solutions from HYDAC results in significant fuel savings. Increases in productivity and the reduction of brake-wear are further examples of achievable benefits.

Accumulators in the hybrid system

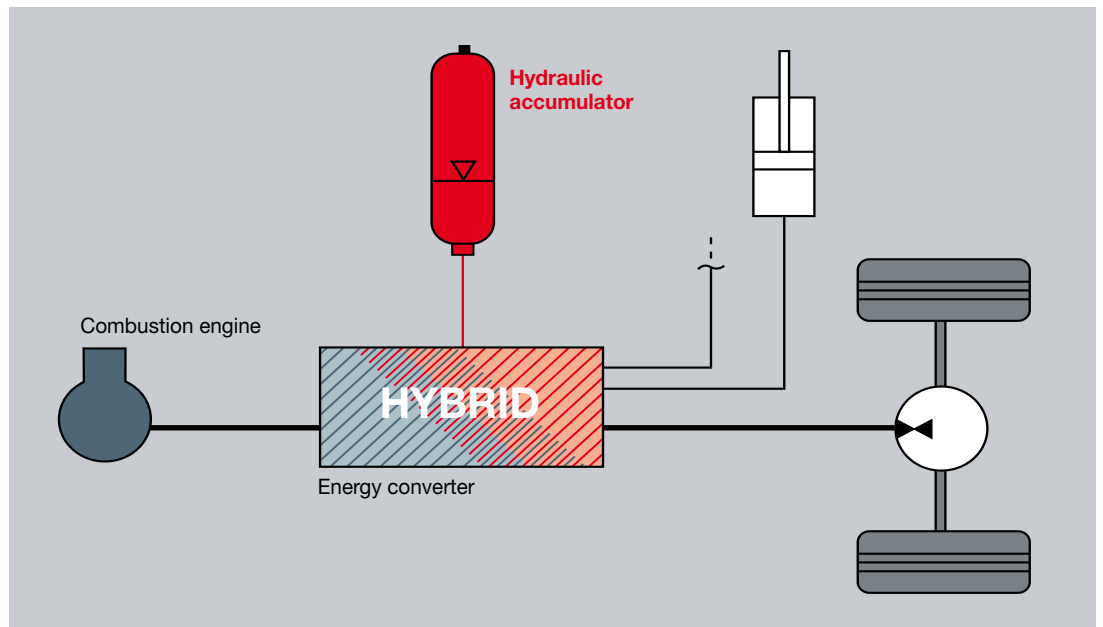

Measures / Strategies

- Energy recovery
- Boost operation
- Downsizing
- Shift of the operating point / Peak shaving
- Hydraulic start-stop operation
- Decoupling of auxiliary equipment

Benefits

- Fuel saving
- Productivity increase
- Reduction in brake-wear
- Noise control
- Expansion of application opportunities (e.g. indoor)
- Lower expenditure on after-treatment of exhaust gases

Hydraulic Accumulators – the Driving Force

Accumulators – the New Formula in Hybrid Production.

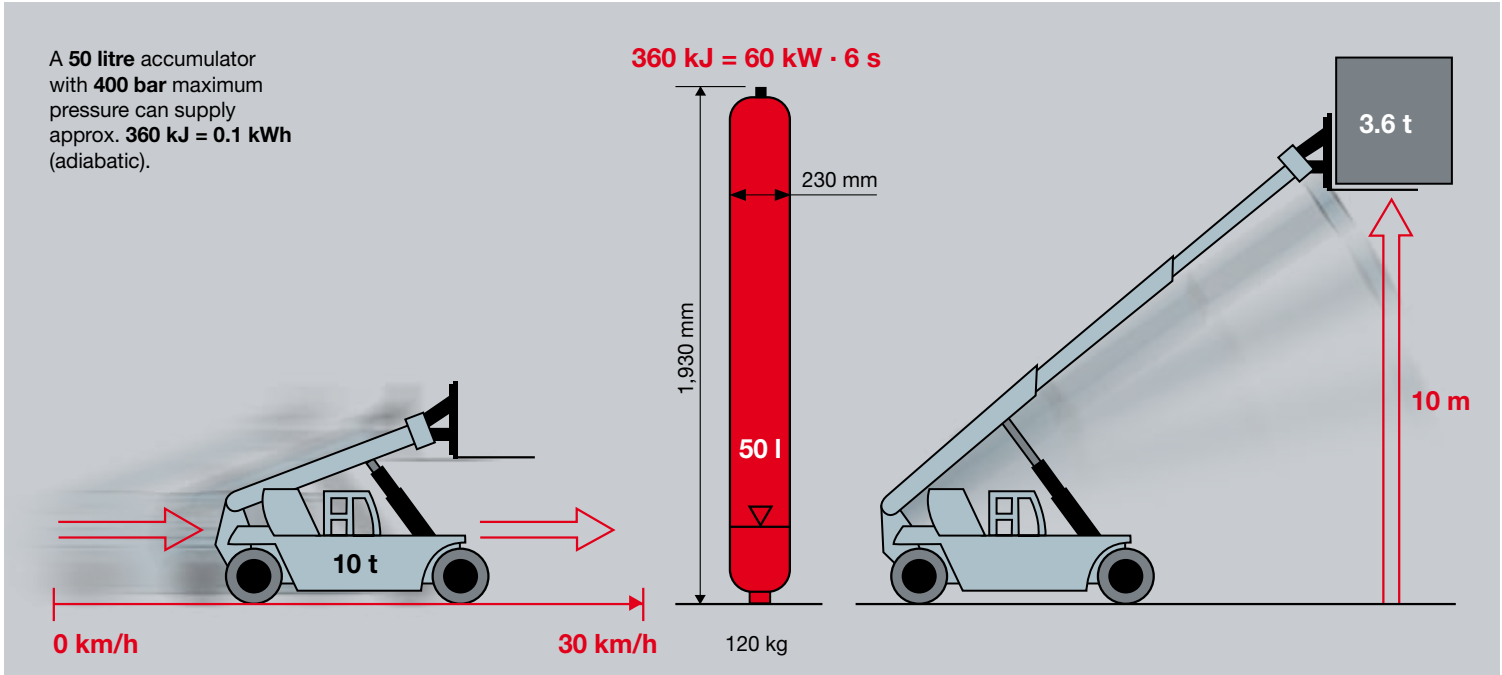

Application Examples.

Load compensation: Material handler

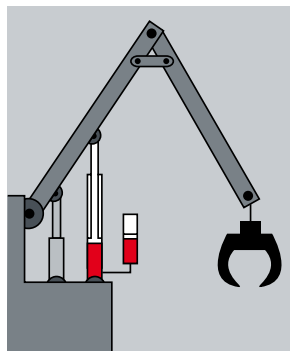
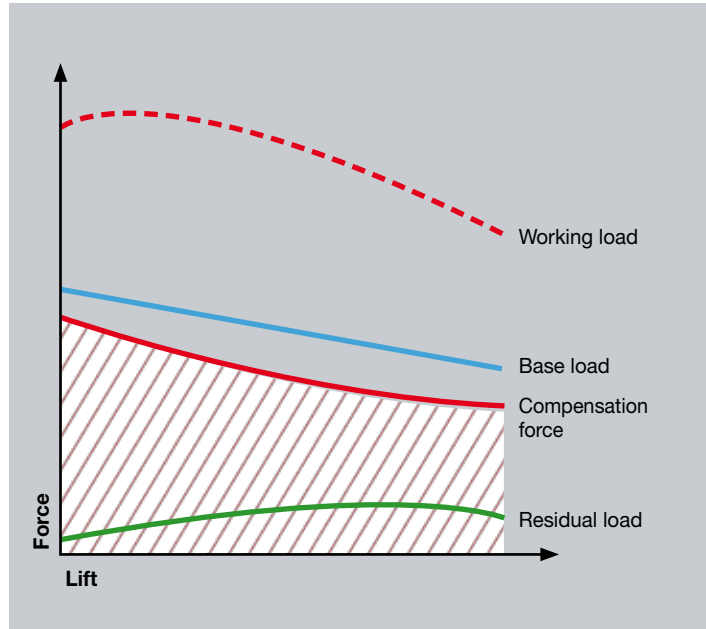

Measure / Strategies:

- Energy recovery
- Downsizing
- Boost operation

Benefits:

- Reduced fuel consumption
- Productivity increase
- Noise protection

Traction drive: Wheel loader

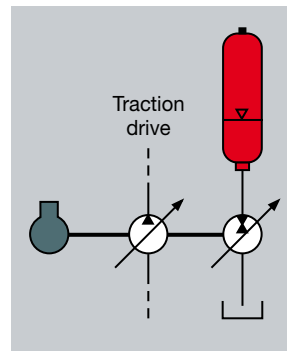
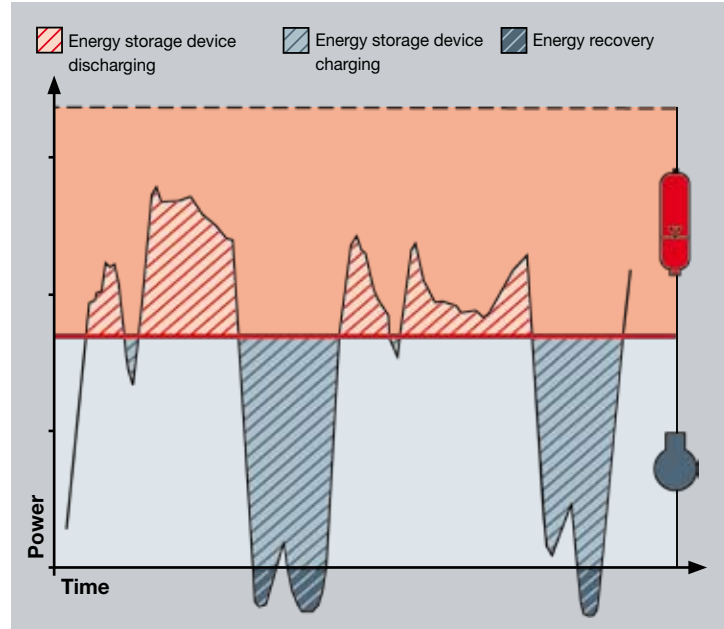

Measure / Strategies:

- Downsizing
- Boost operation
- Shift of the operating point / Peak Shaving
- Hydraulic start-stop operation

Benefits:

- Reduced fuel consumption
- Productivity / performance increase
- Lower expenditure on after-treatment of exhaust gases

in Hybrid Technology.

Engineering Based on Decades of Experience.



Development of Application-Based Hybrid Systems.

Measurement and analysis

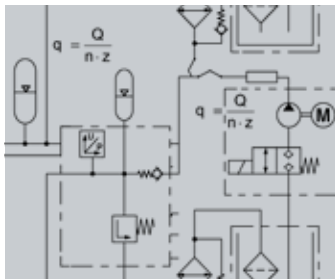

HYDAC supports its customers right from development of the machine. When it comes to measuring and analysing typical cycles of mobile machines, HYDAC is the best partner because of our varied and robust measuring technology products.

Accumulator packaging



HYDAC has a wide range of accumulators (bladder and piston accumulators, nitrogen bottles) as well as robust mounting technology to ensure it is ideally packaged, especially in confined installation spaces.

Development of hybrid concepts

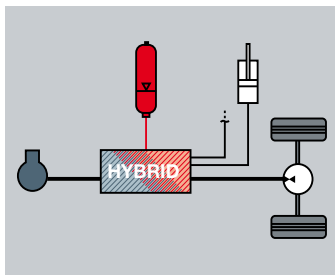

On the basis of measured data analysis, concepts for hybrid drive structures are worked out in discussion with the customer. At the same time, we build both on our wide experience in mobile hydraulics and on decades of expertise in working with accumulators.

Analysis of the prototype

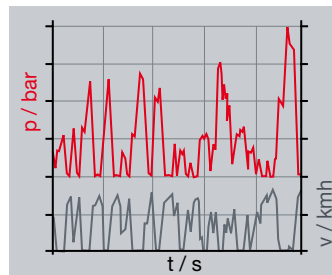

When analysing the prototype, the functioning of the hybrid system is examined. The temperature fluctuations occurring in the accumulator are helpful to estimate its durability. On the basis of the collected data, further measures for improvement can be planned and implemented.

Simulating and sizing hydraulic accumulators



The ASP simulation program takes into account the real gas behaviour and the heat exchange of the accumulator with the environment. This ensures that the thermodynamic processes are represented accurately and correspond to real-world conditions. The accumulator model can also be integrated into the simulation environments of Matlab / Simulink and AMESim.

Optimisation of the accumulator parameters

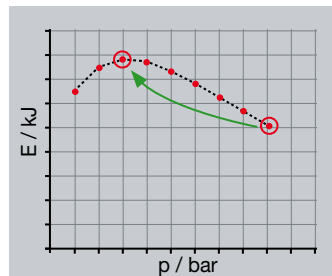

Based on the analysis of the prototype, the accumulator parameters (accumulator size, pre-charge pressure, min. and max. operating pressure) are adjusted with the help of the simulation software for hybrid systems, to take account of the application.

Tried-and-Tested Standard Components.



All types of accumulator

Bladder, piston and diaphragm accumulators, as well as nitrogen bottles (for back-up configurations) available from one company

Proven safety equipment

Safety and shut-off blocks, gas safety valves, bursting discs and temperature fuses

Monitoring sensors

Pressure sensors, linear measurement systems and oil condition sensors

Control equipment

To EN 13849 for almost all requirement levels (SIL2/3 or PLd)

Extensive valve portfolio

Directional, proportional, flow control and pressure valves

Mounting technology

Swivel bolt clamps and U-bolt clamps, consoles

Innovative Hybrid Solutions.

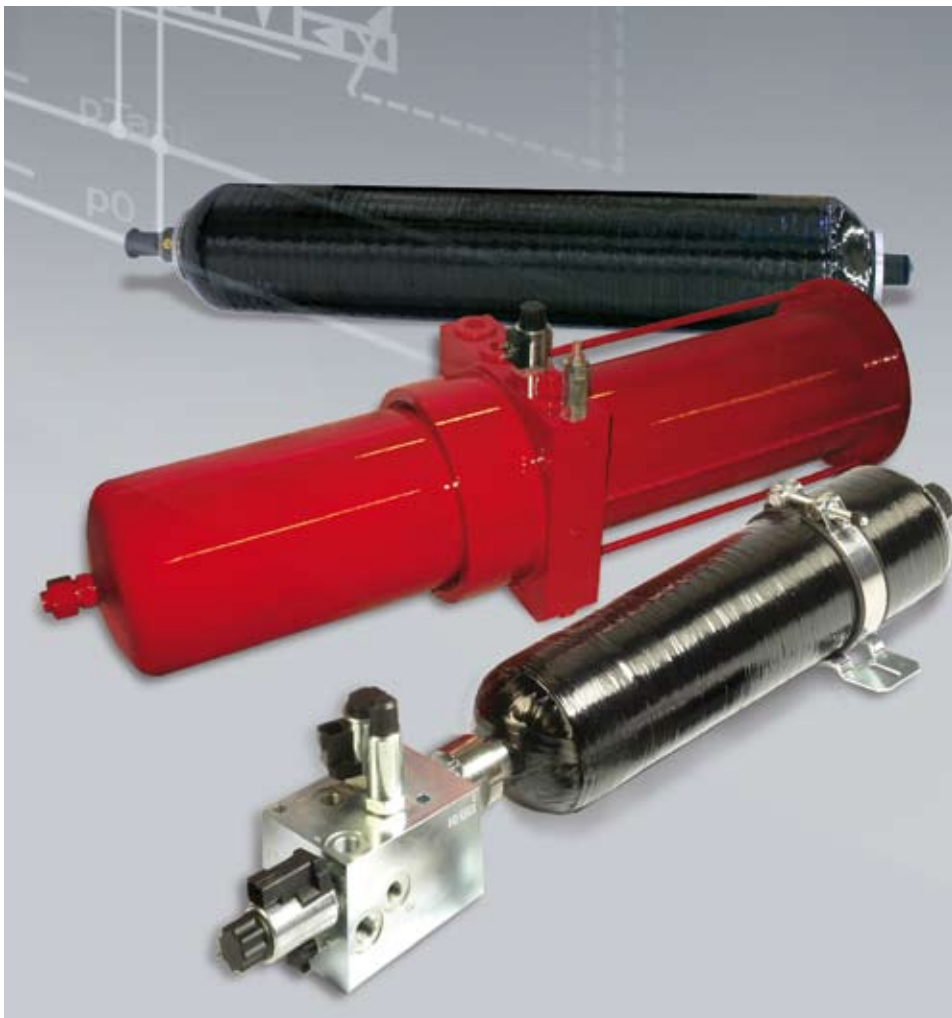

Weight-reduced accumulators

Their low weight is achieved by a carbon-fibre hoop-wrapped accumulator shell or by a so-called fully composite construction where an inner plastic liner has a full carbon fibre winding.

The use of alternative materials, such as aluminium, is another means of optimizing the weight of accumulators.

Double piston accumulator

These provide optimum suction conditions on the suction side of the hydrostatic drive at all times, and in comparison to conventional systems with a high and a low pressure side, have higher energy and power capacities.

Moreover, innovative energy saving solutions can be built for hydraulic load compensation with the help of double piston accumulators.

Special hydraulic blocks

These are designed on the basis of individual requirements in close cooperation with the customer. They offer maximum efficiency, functionality and reliability.

Expertise from Development through to Service - Worldwide.

Our Experience is your Advantage.

HYDAC is the only manufacturer producing hydraulic accumulators of all major types, namely bladder, piston, diaphragm and metal bellows accumulators, including innovative special solutions.



Owing to above-average efficiency, safety and service life, the accumulator solutions from HYDAC are extremely economical. These solutions are used not only for shock absorption, pressure maintenance, pulsation damping or for emergency functions, but also as a means of reducing costs through energy recovery, for example, in the area of modern hybrid technology.

There are examples of applications for HYDAC accumulator technology in all sectors of industry worldwide – with the best of references from leading manufacturers and operators.



The HYDAC accumulator range is complemented by its perfect fluid conditioning service. This is available as a package or as individual services, and ranges from analysis and diagnostics, monitoring and cleaning through to measures to improve fluid power circuits.

To ensure perfect fluid service when carried out by your own staff, HYDAC can provide training, equipment and systems.

Our concern is to improve the operational availability of hydraulic systems and machinery.

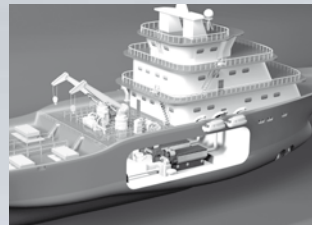
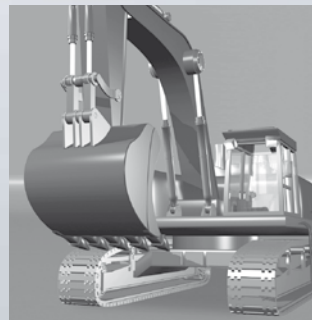



Accumulators E 30.000



Filter Technology E 70.000



Process Technology E 77.000



Filter Systems E 79.000



Compact Hydraulics E 53.000



Accessories E 61.000



Electronics E 180.000



Cooling Systems DEF 5.700

Global Presence. Local Expertise. www.hydac.com



- HYDAC Headquarters
- HYDAC Companies
- HYDAC Sales and Service Partners

HYDAC INTERNATIONAL

Head Office
HYDAC INTERNATIONAL
GMBH

Industriegebiet
66280 Sulzbach/Saar
Germany

Telephone:
+49 6897 509-01

Fax:
+49 6897 509-577

E-Mail: hybrid@hydac.com
Internet: www.hydac.com