



Filter Clogging Indicators

1. TECHNICAL SPECIFICATIONS

1.1 GENERAL

HYDAC clogging indicators are designed to indicate visually and/or electrically when the filter elements must be cleaned or changed. The operational safety of a system and efficient utilisation of a filter element can only be guaranteed if clogging indicators are used.

Depending on the type of filter, vacuum, return line or differential pressure clogging indicators are used.

1.2 SEALS

NBR (= Perbunan) or V (= Viton)

1.3 INSTALLATION

Some users install filters without clogging indicators and prefer instead to replace or clean the elements according to a specified time schedule or according to a set number of operating hours. However, this involves some risk.

Fitting a clogging indicator has two main advantages:

- The operator no longer has to estimate when the element is clogged.
 - The unnecessary costs of changing the element too early are avoided.
- All standard filters can be fitted with a clogging indicator at any time, by simply screwing it in.

1.4 DESIGN

Return line indicators

These are used for return line and suction filters. In return line filters they react to the increasing static pressure before the filter element, and in suction filters to the decreasing pressure after the filter element, which is caused by increasing contamination.

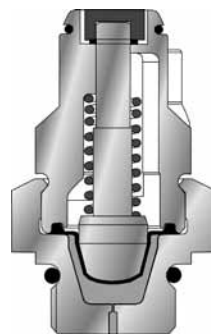

Differential pressure indicators

These are used for all inline filters and react to the increasing pressure differential caused by increasing contamination of the filter element.

The most simple installation of the differential clogging indicator: G 1/2" cavity (according to HYDAC works standard HN 28-22)

The differential pressure indicator type V02 is piped up separately.

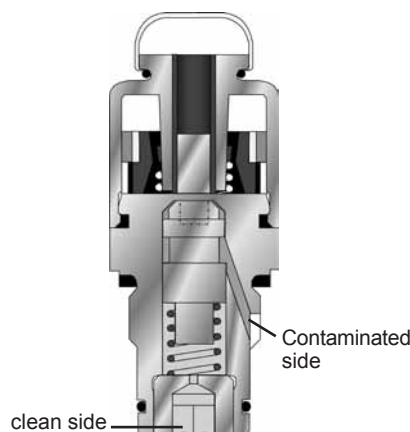

1.4 SPECIAL INDICATORS

Mobile indicators

These indicators have been developed for special applications and are fitted with AMP, Deutsch and Junior Power Timer plugs.

ATEX indicators

These indicators are used in potentially explosive locations and are subject to the ATEX Equipment Directive 94/9/EC and the ATEX Operator Directive 1999/92/EC.



UL and CSA indicators

Indicators which are exported to the USA and Canada often require classification according to current UL and CSA standards. The UL and CSA symbols are found on many products, particularly in the field of electrical engineering.



1.6 TABLE OF CONTENTS

Contents	Page:
Quick selection table: by indicator type	64
Quick selection table: by filter type	65
Standard indicators	
Vacuum	66
Return line	69
Differential pressure	83
Indicator VL for Condition Monitoring	86
Mobile indicators	
Return line	91
Differential pressure	93
ATEX indicators	
Return line	96
Differential pressure	98
UL/CSA indicators	
Differential pressure	100
Return line	101
Model code - Standard	102
Adapters	104
DESINA Specification	106

2. QUICK SELECTION TABLES FOR CLOGGING INDICATORS

2.1 BY INDICATOR TYPE

Please select the type of indicator you require from the table.

Type		Vacuum indicator	Return line indicator	Differential pressure indicator
Visual	B		●	●
	BF			●
	BM			●
	E		●	
	ES		●	
	K	●		
	R		●	
	UBM	●		
	UE	●		
	UED	●		
	V			●
Electrical	C		●	●
	D		●	●
	F		●	
	LE		●	●
	LZ		●	●
	UF	●		
	VE			●
	VZ			●
Electronic	GC		●	●
	GW			●
Mobile	CD		●	●
	CJ		●	●
	CM		●	●
	FD		●	
	LEM		●	●
	M			●
ATEX	B		●	●
	C		●	●
UL Approval (= CRUUS)	C			●
	D			●
CSA Approval	C		●	

2.2 BY FILTER TYPE

Please select the clogging indicator required for your filter from the table.

Type	BF	BL	BLT	DF DFF	DFDK	DF MA/QE	DFM	DFN DFNF	DFP DFPF	DFZ	ELF	FLN	FLND FMND	HDF HDFD	HDP	HFM	LF LFF	LFM	LFN LFNF
B				•	•	•	•	•				•	•	•		•	•	•	•
BF																			
BM				•	•	•	•	•	•	•		•	•	•		•	•	•	•
E																			
ES																			
K	•	•	•								•								
R																			
UBM	•	•	•								•								
UE												• ¹⁾						• ¹⁾	
UED														•					
V																			
C				•	•	•	•	•	•	•		•	•	•		•	•	•	•
D				•	•	•	•	•	•	•		•	•	•		•	•	•	•
F																			
LE				•	•	•	•	•	•	•		•	•	•		•	•	•	•
LZ				•	•	•	•	•	•	•		•	•	•		•	•	•	•
UF												• ¹⁾						• ¹⁾	
VE																			
VZ																			
GC				•	•	•	•	•	•	•		•	•	•		•	•	•	•
GW																			
CD				•	•	•	•	•	•	•		•	•	•		•	•	•	•
CJ				•	•	•	•	•	•	•		•	•	•		•	•	•	•
CM												•	•				•	•	•
FD																			
M												•	•				•	•	•
LEM				•	•	•	•	•	•	•		•	•	•		•	•	•	•



Type	LPF	MDF	MF	MFD	MFM	MFX	NF	NFD	RF	RFD	RFL	RFLD	RFN	RFND	RFM	RKM	SF	SFF	SFM
B	•	•			•	•			•	•	•	•	•	•	•	•			
BF	•					•													
BM	•	•			•	•	•	•			•	•							
E			• ²⁾	• ²⁾					•	•			•	•	•				
ES									•	•			•	•	•				
K																			
R																•			
UBM																			
UE	• ¹⁾		• ¹⁾	• ¹⁾							• ¹⁾					•	•	•	•
V											•	•							
C	•	•			•	•	•	•	•	•	•	•	•	•	•	•			
D	•	•			•	•	•	•	•	•	•	•	•	•	•	•			
F			•	•					•	•			•	•	•	•			
LE	•	•			•	•	•	•	•	•	•	•	•	•	•	•			
LZ	•	•			•	•	•	•	•	•	•	•	•	•	•	•			
UF	• ¹⁾		• ¹⁾	• ¹⁾							• ¹⁾					•	•	•	•
VE											•	•							
VZ											•	•							
GC	•	•			•		•	•	•	•	•	•	•	•	•	•			
GW	•						•	•			•	•							
CD	•	•			•		•	•	•	•	•	•	•	•	•	•			
CJ	•	•			•		•	•	•	•	•	•	•	•	•	•			
CM	•					•	•	•	•	•	•	•	•	•	•	•			
FD			•	•					•	•			•	•	•	•			
M	•					•													
LEM	•	•			•	•	•	•	•	•	•	•	•	•	•	•			

¹⁾ Can only be used for suction operation ²⁾ Use VMF 16 E.0 only

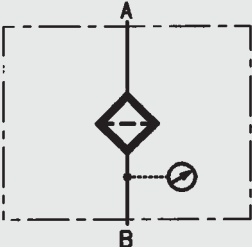
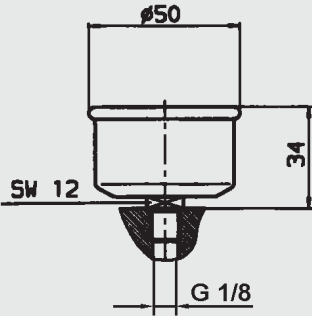

3. SPECIFICATIONS

3.1 VACUUM INDICATORS

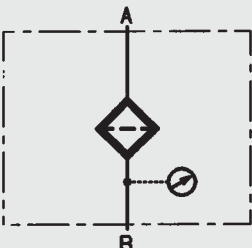
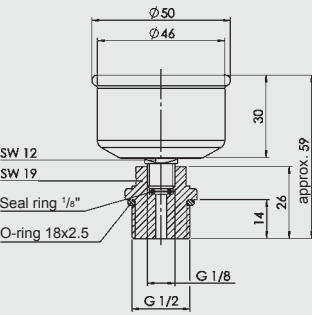

VMF x UE.x

 	Type of indication	visual-analogue, scale indication	 
	Weight	100 g	
	Setting pressure or indication range	-1 bar to 0 bar	
	Permitt. operating pressure	-0.7 to 0 bar continuous	
	Permitt. temperature range	-20 °C to +60 °C	
	Thread	G 1/8	
	Max. torque	15 Nm	
	Switching type	-	
	Max. switching voltage	-	
	Electrical connection	-	
	Max. switching voltage at resistive load	-	
	Switching capacity	-	
	Protection class to DIN 40050	-	
Order example	VMF 1 UE.0		

VR x UE.x

 	Type of indication	visual-analogue, scale indication	 
	Weight	100 g	
	Pressure setting or indication range	-1 bar to 0 bar	
	Permitt. operating pressure	-0.7 to 0 bar continuous	
	Permitt. temperature range	-20 °C to +60 °C	
	Thread	G 1/2	
	Max. torque	30 Nm	
	Switching type	-	
	Max. switching voltage	-	
	Electrical connection	-	
	Max. switching voltage at resistive load	-	
	Switching capacity	-	
	Protection class to DIN 40050	-	
Order example	VR 1 UE.0		

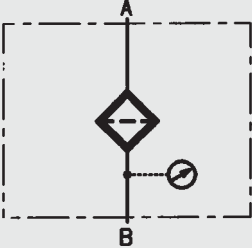
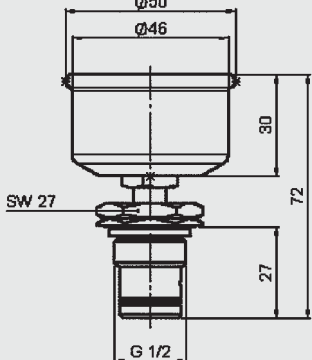
VRD x UE.x

 	Type of indication	visual-analogue, scale indication	 
	Weight	145 g	
	Pressure setting or indication range	-1 bar to 0 bar	
	Permitt. operating pressure	-0.7 to 0 bar continuous	
	Permitt. temperature range	-20 °C to +60 °C	
	Thread	G 1/2	
	Max. torque	33 Nm	
	Switching type	-	
	Max. switching voltage	-	
	Electrical connection	-	
	Max. switching voltage at resistive load	-	
	Switching capacity	-	
	Protection class to DIN 40050	-	
Order example	VRD 1 UE.0		

VMF x UF.x

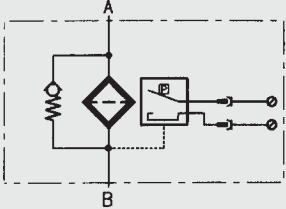
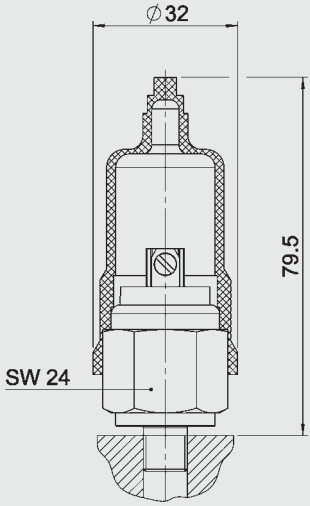
 	Type of indication	electrical switch	
	Weight	170 g	
	Pressure setting or indication range	-0.2 bar ± 0.1 bar	
	Permitt. operating pressure	20 bar	
	Permitt. temperature range	-30 °C to +100 °C	
	Thread	G 1/8	
	Max. torque	15 Nm	
	Switching type	N/O contact	
	Max. switching voltage	48 V	
	Electrical connection	threaded connection	
	Max. switching voltage at resistive load	60 W = 100 VA ~	
	Switching capacity	ohmic 2.5 A at 24 V = ohmic 2.5 A at 42 V ~	
	Protection class to DIN 40050	IP 65, terminals IP 00	
Order example	VMF 0.2 UF.0		

VR x UF.x

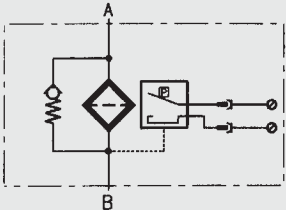
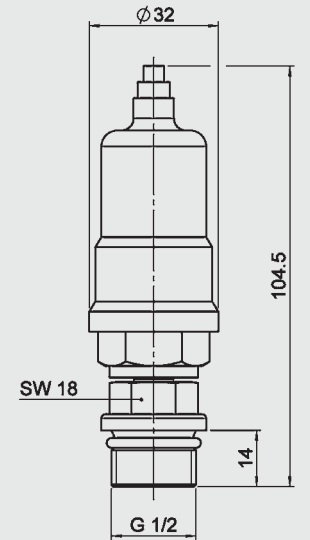
 	Type of indication	electrical switch	
	Weight	170 g	
	Pressure setting or indication range	-0.2 bar ± 0.1 bar	
	Permitt. operating pressure	20 bar	
	Permitt. temperature range	-30 °C to +100 °C	
	Thread	G 1/2	
	Max. torque	30 Nm	
	Switching type	N/O contact	
	Max. switching voltage	48 V	
	Electrical connection	threaded connection	
	Max. switching voltage at resistive load	60 W = 100 VA ~	
	Switching capacity	ohmic 2.5 A at 24 V = ohmic 2.5 A at 42 V ~	
	Protection class to DIN 40050	IP 65, terminals IP 00	
Order example	VR 0.2 UF.0		

VRD x UF.x

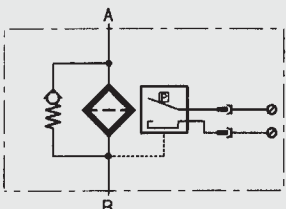
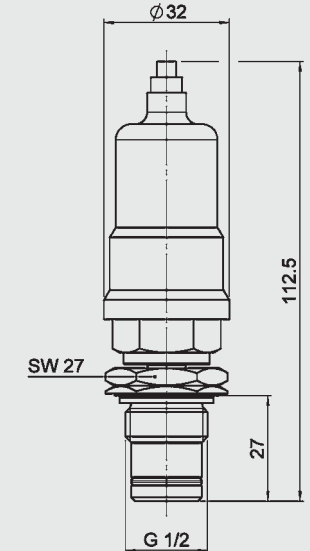
 	Type of indication	electrical switch	
	Weight	170 g	
	Pressure setting or indication range	-0.2 bar ± 0.1 bar	
	Permitt. operating pressure	20 bar	
	Permitt. temperature range	-30 °C to +100 °C	
	Thread	G 1/2	
	Max. torque	33 Nm	
	Switching type	N/O contact	
	Max. switching voltage	48 V	
	Electrical connection	threaded connection	
	Max. switching voltage at resistive load	60 W = 100 VA ~	
	Switching capacity	ohmic 2.5 A at 24 V = ohmic 2.5 A at 42 V ~	
	Protection class to DIN 40050	IP 65, terminals IP 00	
Order example	VRD 0.2 UF.0		

VMF x UBM.x

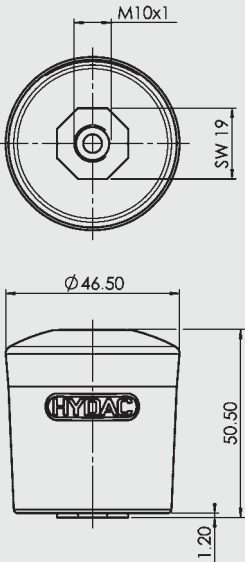
	Type of indication	visual, yellow pin	
	Weight	0.05 g	
	Pressure setting or indication range	-0.035 bar	
	Permitt. operating pressure	1 bar	
	Permitt. temperature range	-30 °C to +100 °C	
	Thread	M10 x 1	
	Max. torque	15 Nm	
	Switching type	-	
	Max. switching voltage	-	
	Electrical connection	-	
	Max. switching voltage at resistive load	-	
	Switching capacity	-	
	Protection class to DIN 40050	-	
	Order example	VMF 0.035 UBM.0	

VMF x UED.x

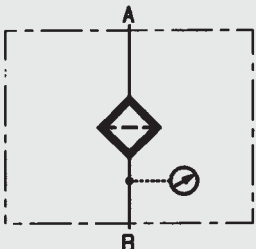
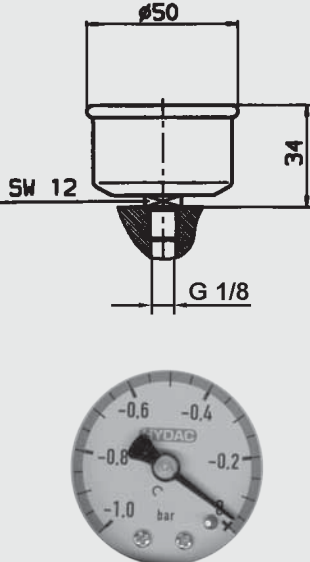
 	Type of indication	visual-analogue, scale indication (filled with silicone oil)	
	Weight	100 g	
	Pressure setting or indication range	-1 bar to 0 bar	
	Permitt. operating pressure	-0.7 to 0 bar continuous	
	Permitt. temperature range	-20 °C to +90 °C	
	Thread	G 1/8	
	Max. torque value	15 Nm	
	Switching type	-	
	Max. switching voltage	-	
	Electrical connection	-	
	Max. switching voltage at resistive load	-	
	Switching capacity	-	
	Protection class to DIN 40050	-	
	Order example	VMF 1 UED.0	

3.2 RETURN LINE INDICATORS

VMF x B.x

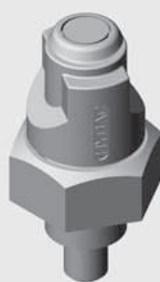
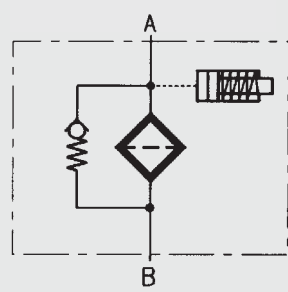
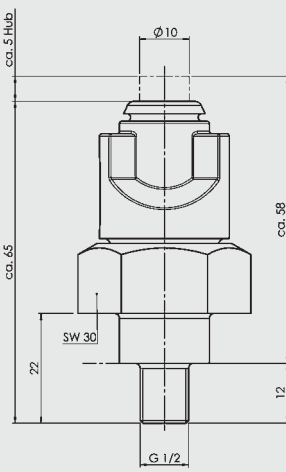
 	Type of indication	visual, red pin	
	Weight	84 g	
	Pressure setting or indication range	2 bar - 0.2 bar	
	Permitt. operating pressure	7 bar	
	Permitt. temperature range	-30 °C to +100 °C	
	Thread	G 1/8	
	Max. torque	15 Nm	
	Switching type	-	
	Max. switching voltage	-	
	Electrical connection	-	
	Max. switching voltage at resistive load	-	
	Switching capacity	-	
	Protection class to DIN 40050	-	
	Order example	VMF 2 B.1	

VR x B.x

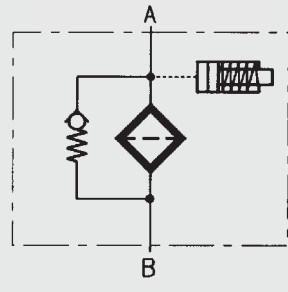
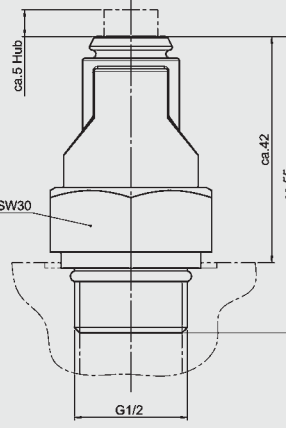
 	Type of indication	visual, red pin	
	Weight	44 g	
	Pressure setting or indication range	2 bar - 0.2 bar	
	Permitt. operating pressure	7 bar	
	Permitt. temperature range	-30 °C to +100 °C	
	Thread	G 1/2	
	Max. torque	15 Nm	
	Switching type	-	
	Max. switching voltage	-	
	Electrical connection	-	
	Max. switching voltage at resistive load	-	
	Switching capacity	-	
	Protection class to DIN 40050	-	
	Order example	VR 2 B.1	

VMF x C.x

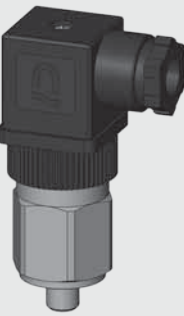
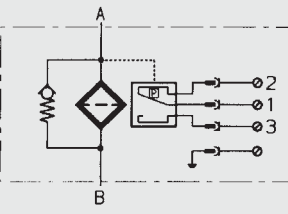
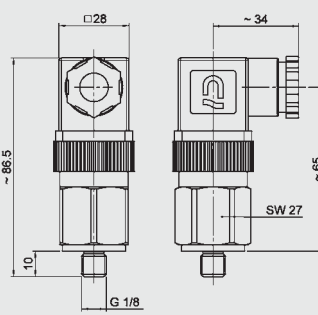
 	Type of indication	electrical switch	
	Weight	270 g	
	Pressure setting or indication range	2 bar - 0.3 bar	
	Permitt. operating pressure	40 bar	
	Permitt. temperature range	-30 °C to +100 °C	
	Thread	G 1/8	
	Max. torque	15 Nm	
	Switching type	N/C or N/O (change-over contacts)	
	Max. switching voltage	230 V	
	Electrical connection	Male connection M20 Female connector to DIN 43650	
	Max. switching voltage at resistive load	250 W = 300 VA ~	
	Switching capacity	Ohmic 6 A at 24 V = Ohmic 0.03 to 6 A at max. 230 V ~	
	Protection class to DIN 40050	IP 65 (only if the connector is wired and fitted correctly)	
	Order example	VMF 2 C.1	

VR x C.x

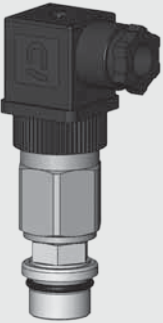
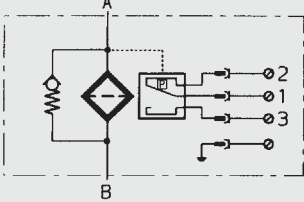
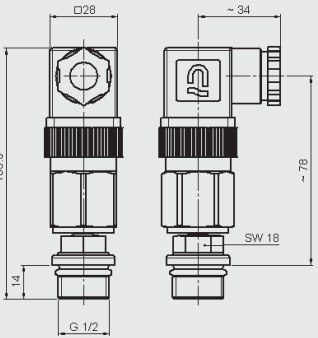
 	Type of indication	electrical switch	
	Weight	340 g	
	Pressure setting or indication range	2 bar - 0.3 bar	
	Permitt. operating pressure	40 bar	
	Permitt. temperature range	-30 °C to +100 °C	
	Thread	G 1/2	
	Max. torque	30 Nm	
	Switching type	N/C or N/O (change-over contacts)	
	Max. switching voltage	230 V	
	Electrical connection	Male connection M20 Female connector to DIN 43650	
	Max. switching voltage at resistive load	250 W = 300 VA ~	
	Switching capacity	ohmic 6 A at 24 V ohmic 0.03 to 6 A at max. 230 V ~	
	Protection class to DIN 40050	IP 65 (only if the connector is wired and fitted correctly)	
Order example	VR 2 C.1		

VRD x C.x

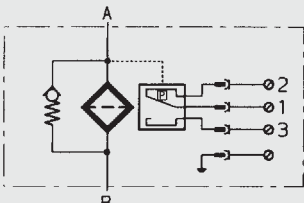
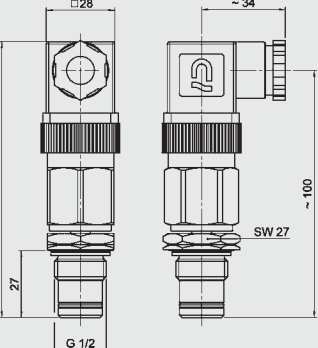
 	Type of indication	electrical switch	
	Weight	340 g	
	Pressure setting or indication range	2 bar - 0.3 bar	
	Permitt. operating pressure	40 bar	
	Permitt. temperature range	-30 °C to +100 °C	
	Thread	G 1/2	
	Max. torque	33 Nm	
	Switching type	N/C or N/O (change-over contacts)	
	Max. switching voltage	230 V	
	Electrical connection	Male connection M20 Female connector to DIN 43650	
	Max. switching voltage at resistive load	250 W = 300 VA ~	
	Switching capacity	ohmic 6 A at 24 V ohmic 0.03 to 6 A at max. 230 V ~	
	Protection class to DIN 40050	IP 65 (only if the connector is wired and fitted correctly)	
Order example	VRD 2 C.1		

VMF x D.x /-L...

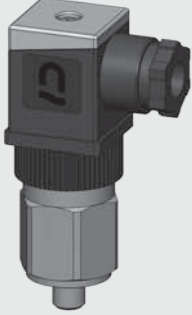
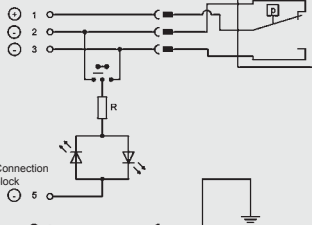
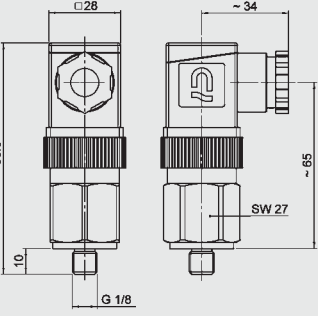
 	Type of indication	visual indicator and electrical switch	
	Weight	300 g	
	Pressure setting or indication range	2 bar - 0.3 bar	
	Permitt. operating pressure	40 bar	
	Permitt. temperature range	-30 °C to +100 °C	
	Thread	G 1/8	
	Max. torque value	15 Nm	
	Switching type	N/C or N/O (change-over contacts)	
	Max. switching voltage	24, 48, 110, 230 V (depending on the type of light insert)	
	Electrical connection	Male connection M20 Female connector to DIN 43650	
	Max. switching voltage at resistive load	250 W = 300 VA ~	
	Switching capacity	Ohmic 6 A at 230 V = Ohmic 0.03 to 6 A at max. 230 V ~	
	Protection class to DIN 40050	IP 65 (only if the connector is wired and fitted correctly)	
Order example	VMF 2 D.1 /-L24		

VR x D.x /-L...

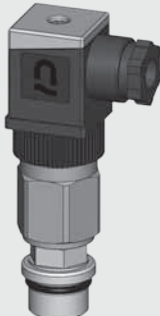
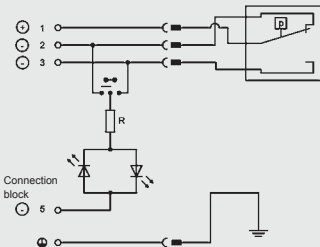
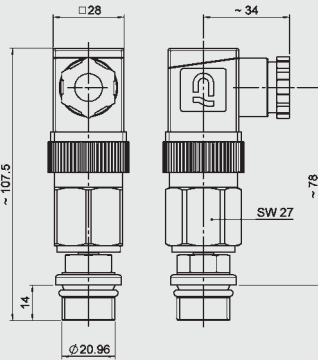
 	Type of indication	visual indicator and electrical switch	
	Weight	360 g	
	Pressure setting or indication range	2 bar - 0.3 bar	
	Permitt. operating pressure	40 bar	
	Permitt. temperature range	-30 °C to +100 °C	
	Thread	G 1/2	
	Max. torque value	30 Nm	
	Switching type	N/C or N/O (change-over contacts)	
	Max. switching voltage	24, 48, 110, 230 V (depending on the type of light insert)	
	Electrical connection	Male connection M20 Female connector to DIN 43650	
	Max. switching voltage at resistive load	250 W = 300 VA ~	
	Switching capacity	Ohmic 6 A at 24 V = Ohmic 0.03 to 6 A at max. 230 V ~	

Protection class to DIN 40050 IP 65 (only if the connector is wired and fitted correctly)

Order example VR 2 D.1 /-L110

VRD x D.x /-L...

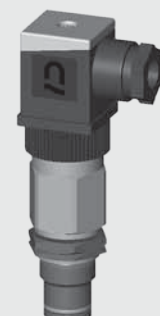
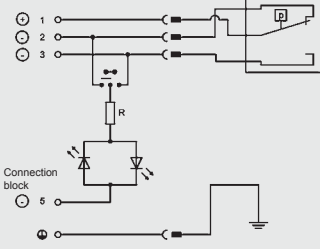
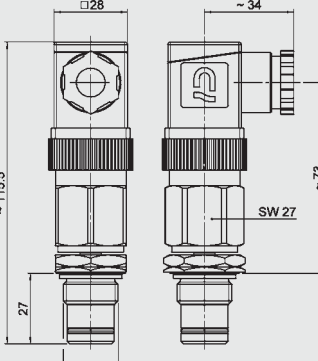
 	Type of indication	visual indicator and electrical switch	
	Weight	360 g	
	Pressure setting or indication range	2 bar - 0.3 bar	
	Permitt. operating pressure	40 bar	
	Permitt. temperature range	-30 °C to +100 °C	
	Thread	G 1/2	
	Max. torque value	33 Nm	
	Switching type	N/C or N/O (change-over contacts)	
	Max. switching voltage	24, 48, 110, 230 V (depending on the type of light insert)	
	Electrical connection	Male connection M20 Female connector to DIN 43650	
	Max. switching voltage at resistive load	250 W = 300 VA ~	
	Switching capacity	Ohmic 6 A at 24 V = Ohmic 0.03 to 6 A at max. 230 V ~	

Protection class to DIN 40050 IP 65 (only if the connector is wired and fitted correctly)

Order example VRD 2 D.1 /-L110

VMF x D.x /-LED

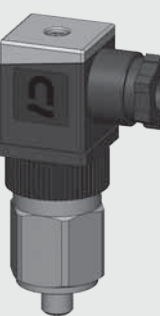
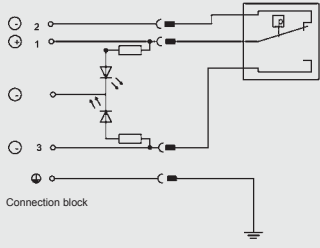
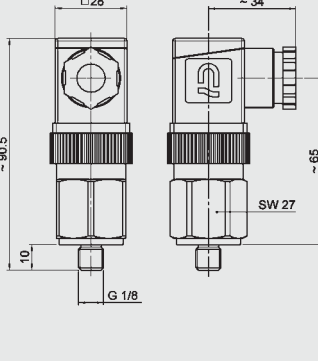
 	Type of indication	visual indicator and electrical switch	
	Weight	300 g	
	Pressure setting or indication range	2 bar - 0.3 bar	
	Permitt. operating pressure	40 bar	
	Permitt. temperature range	-30 °C to +100 °C	
	Thread	G 1/8	
	Max. torque value	15 Nm	
	Switching type	N/O contact	
	Max. switching voltage	24 V	
	Electrical connection	Male connection M20 Female connector to DIN 43650	
	Max. switching voltage at resistive load	250 W = 300 VA ~	
	Switching capacity	ohmic 6 A at 24 V =	

Protection class to DIN 40050 IP 65 (only if the connector is wired and fitted correctly)

Order example VMF 2 D.1 /-LED

VR x D.x /-LED

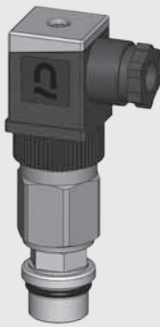
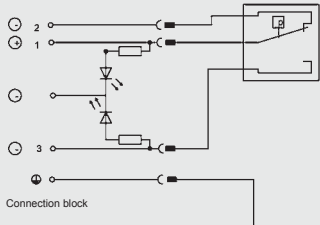
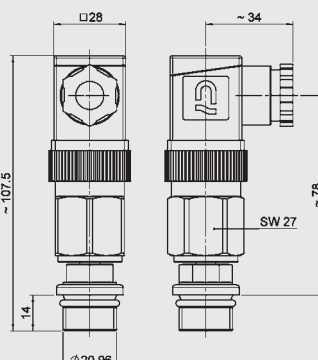
  <p>Connection block</p>	Type of indication	visual indicator and electrical switch	
	Weight	360 g	
	Pressure setting or indication range	2 bar - 0.3 bar	
	Permitt. operating pressure	40 bar	
	Permitt. temperature range	-30 °C to +100 °C	
	Thread	G 1/8	
	Max. torque value	30 Nm	
	Switching type	N/O contact	
	Max. switching voltage	24 V	
	Electrical connection	Male connection M20 Female connector to DIN 43650	
	Max. switching voltage at resistive load	250 W = 300 VA ~	
	Switching capacity	ohmic 6 A at 24 V =	
	Protection class to DIN 40050	IP 65 (only if the connector is wired and fitted correctly)	
Order example	VR 2 D.1 /-LED		

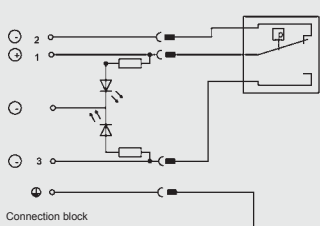
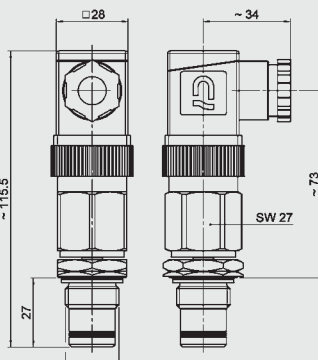

VRD x D.x /-LED

  <p>Connection block</p>	Type of indication	visual indicator and electrical switch	
	Weight	360 g	
	Pressure setting or indication range	2 bar - 0.3 bar	
	Permitt. operating pressure	40 bar	
	Permitt. temperature range	-30 °C to +100 °C	
	Thread	G 1/8	
	Max. torque value	33 Nm	
	Switching type	N/O contact	
	Max. switching voltage	24 V	
	Electrical connection	Male connection M20 Female connector to DIN 43650	
	Max. switching voltage at resistive load	250 W = 300 VA ~	
	Switching capacity	ohmic 6 A at 24 V =	
	Protection class to DIN 40050	IP 65 (only if the connector is wired and fitted correctly)	
Order example	VRD 2 D.1 /-LED		

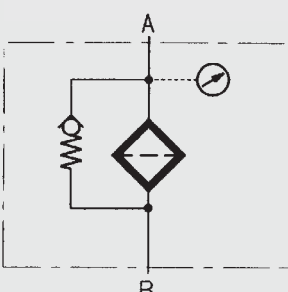
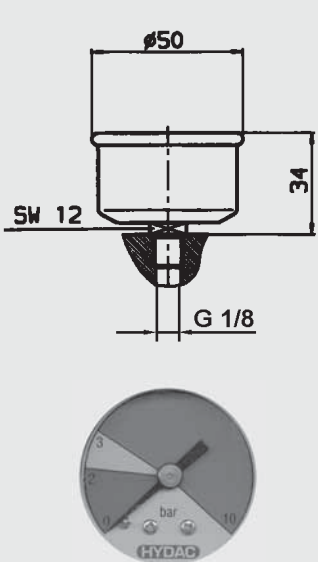

VMF x E.x

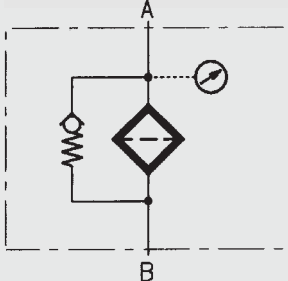
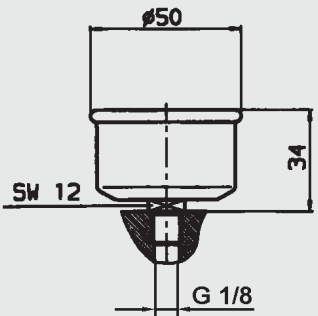
 	Type of indication	visual-analogue, scale indication	
	Weight	80 g	
	Pressure setting or indication range	0 bar to +10 bar	
	Permitt. operating pressure	7 bar continuous	
	Permitt. temperature range	-20 °C to +60 °C	
	Thread	G 1/8	
	Max. torque value	15 Nm	
	Switching type	-	
	Max. switching voltage	-	
	Electrical connection	-	
	Max. switching voltage at resistive load	-	
	Switching capacity	-	
	Protection class to DIN 40050	-	
Order example	VMF 2 E.0		

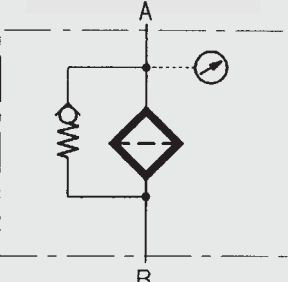
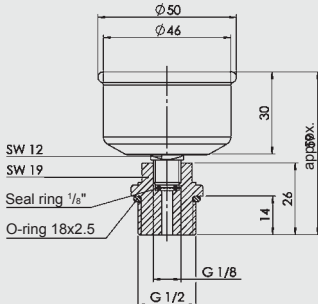

VMF 16 E.x

 	Type of indication	visual-analogue, scale indication	 
	Weight	80 g	
	Pressure setting or indication range	0 bar to +16 bar	
	Permitt. operating pressure	11 bar continuous	
	Permitt. temperature range	-20 °C to +60 °C	
	Thread	G 1/8	
	Max. torque value	15 Nm	
	Switching type	-	
	Max. switching voltage	-	
	Electrical connection	-	
	Max. switching voltage at resistive load	-	
	Switching capacity	-	
	Protection class to DIN 40050	-	
Order example	VMF 16 E.0		

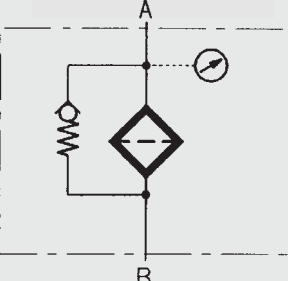
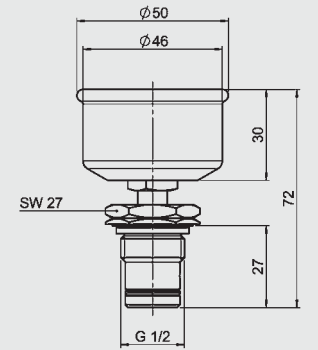

VR x E.x

 	Type of indication	visual-analogue, scale indication	 
	Weight	140 g	
	Pressure setting or indication range	0 bar to +10 bar	
	Permitt. operating pressure	7 bar continuous	
	Permitt. temperature range	-20 °C to +60 °C	
	Thread	G 1/2	
	Max. torque value	30 Nm	
	Switching type	-	
	Max. switching voltage	-	
	Electrical connection	-	
	Max. switching voltage at resistive load	-	
	Switching capacity	-	
	Protection class to DIN 40050	-	
Order example	VR 2 E.0		

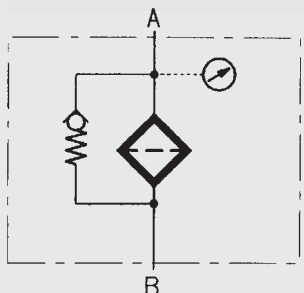
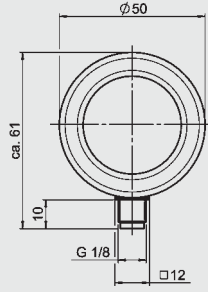
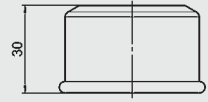

VRD x E.x

 	Type of indication	visual-analogue, scale indication	 
	Weight	140 g	
	Pressure setting or indication range	0 bar to +10 bar	
	Permitt. operating pressure	7 bar continuous	
	Permitt. temperature range	-20 °C to +60 °C	
	Thread	G 1/2	
	Max. torque value	33 Nm	
	Switching type	-	
	Max. switching voltage	-	
	Electrical connection	-	
	Max. switching voltage at resistive load	-	
	Switching capacity	-	
	Protection class to DIN 40050	-	
Order example	VRD 2 E.0		

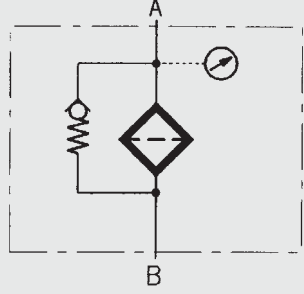
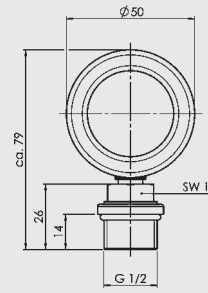

VMF x ES.x

 	Type of indication	visual-analogue, scale indication	  
	Weight	100 g	
	Pressure setting or indication range	0 bar to +10 bar	
	Permitt. operating pressure	7 bar continuous	
	Permitt. temperature range	-20 °C to +60 °C	
	Thread	G 1/8	
	Max. torque value	15 Nm	
	Switching type	-	
	Max. switching voltage	-	
	Electrical connection	-	
	Max. switching voltage at resistive load	-	
	Switching capacity	-	
	Protection class to DIN 40050	-	
Order example	VMF 2 ES.0		

VR x ES.x

 	Type of indication	visual-analogue, scale indication	  
	Weight	120 g	
	Pressure setting or indication range	0 bar to +10 bar	
	Permitt. operating pressure	7 bar continuous	
	Permitt. temperature range	-20 °C to +60 °C	
	Thread	G 1/2	
	Max. torque value	30 Nm	
	Switching type	-	
	Max. switching voltage	-	
	Electrical connection	-	
	Max. switching voltage at resistive load	-	
	Switching capacity	-	
	Protection class to DIN 40050	-	
Order example	VR 2 ES.0		

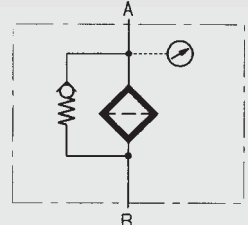
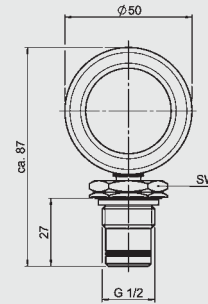
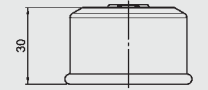
VRD x ES.x

 	Type of indication	visual-analogue, scale indication	  
	Weight	120 g	
	Pressure setting or indication range	0 bar to +10 bar	
	Permitt. operating pressure	7 bar continuous	
	Permitt. temperature range	-20 °C to +60 °C	
	Thread	G 1/2	
	Max. torque value	33 Nm	
	Switching type	-	
	Max. switching voltage	-	
	Electrical connection	-	
	Max. switching voltage at resistive load	-	
	Switching capacity	-	
	Protection class to DIN 40050	-	
Order example	VRD 2 ES.0		

VMF x F.x

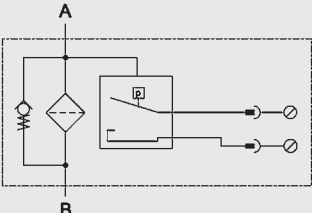
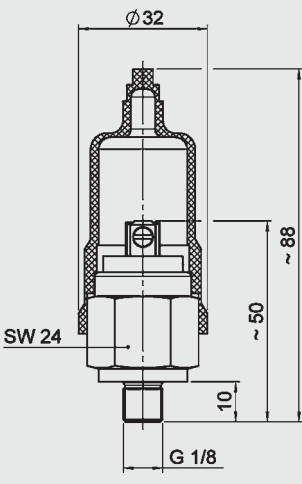
 	Type of indication	electrical switch	
	Weight	70 g	
	Pressure setting or indication range	2 bar ± 0.4 bar	
	Permitt. operating pressure	40 bar	
	Permitt. temperature range	-30 °C to +100 °C	
	Thread	G 1/8	
	Max. torque value	15 Nm	
	Switching type	N/O contact (N/C as an option)	
	Max. switching voltage	42 V	
	Electrical connection	threaded connection	
	Max. switching voltage at resistive load	60 W = 100 VA ~	
	Switching capacity	Ohmic 2.5 A at 24 V = Ohmic 2.5 A at 42 V ~	
	Protection class to DIN 40050	IP 65, terminals IP 00	
Order example	VMF 2 F.0		

VR x F.x

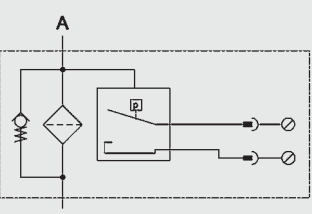
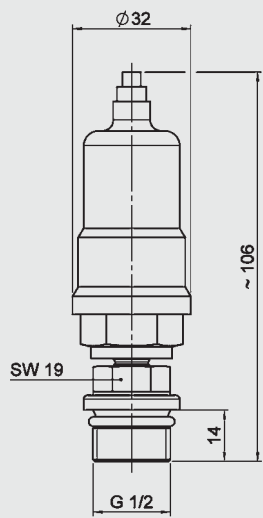
 	Type of indication	electrical switch	
	Weight	130 g	
	Pressure setting or indication range	2 bar ± 0.4 bar	
	Permitt. operating pressure	40 bar	
	Permitt. temperature range	-30 °C to +100 °C	
	Thread	G 1/2	
	Max. torque value	30 Nm	
	Switching type	N/O contact (N/C as an option)	
	Max. switching voltage	42 V	
	Electrical connection	threaded connection	
	Max. switching voltage at resistive load	60 W = 100 VA ~	
	Switching capacity	Ohmic 2.5 A at 24 V = Ohmic 2.5 A at 42 V ~	
	Protection class to DIN 40050	IP 65, terminals IP 00	
Order example	VR 2 F.0		

VRD x F.x

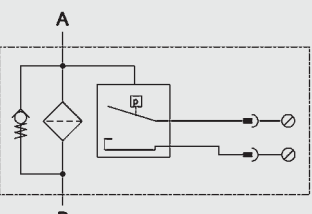
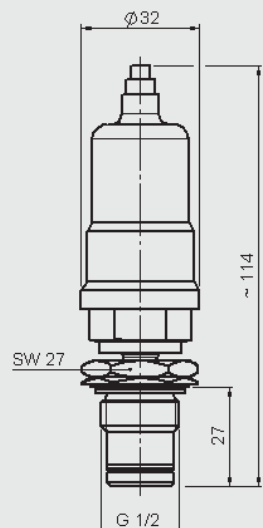
 	Type of indication	electrical switch	
	Weight	130 g	
	Pressure setting or indication range	2 bar ± 0.4 bar	
	Permitt. operating pressure	40 bar	
	Permitt. temperature range	-30 °C to +100 °C	
	Thread	G 1/2	
	Max. torque value	33 Nm	
	Switching type	N/O contact (N/C as an option)	
	Max. switching voltage	42 V	
	Electrical connection	threaded connection	
	Max. switching voltage at resistive load	60 W = 100 VA ~	
	Switching capacity	Ohmic 2.5 A at 24 V = Ohmic 2.5 A at 42 V ~	
	Protection class to DIN 40050	IP 65, terminals IP 00	
Order example	VRD 2 F.0		

VR x GC.x

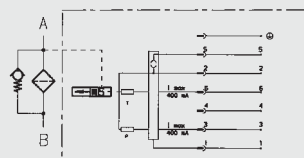
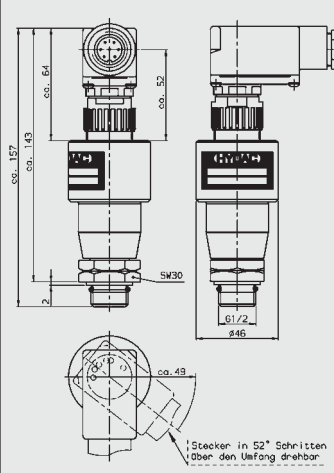
 	Type of indication	Electronic/analogue (4-20 mA or 1-10 V) 1 electrical switching contact at 75% and at 100% of the pressure setting Analogue signal up to 20% of the pressure setting constant 4mA or 1 V	
	Weight	340 g	
	Pressure setting or indication range	2 bar -10%	
	Permitt. operating pressure	7 bar	
	Permitt. temperature range	-30 °C to +80 °C	
	Thread	G 1/2	
	Max. torque value	15 Nm	
	Switching type	N/C or N/O, electronic PNP positive switching (factory setting)	
	Max. switching voltage	Operating voltage 20-30 V DC	
	Electrical connection	7 pole plug to DIN 43651; PG 11	
	Max. switching voltage at resistive load	12 W	
	Switching capacity	ohmic 0.4 A at 30 V =	
	Protection class to DIN 40050	IP 65 (only if the connector is wired and fitted correctly)	
	Order example	VR 2 GC.0 /-LED-SQ-123	

VMF x K.x

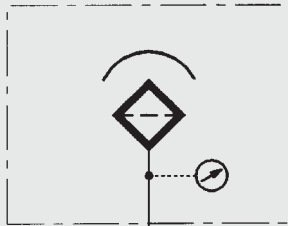
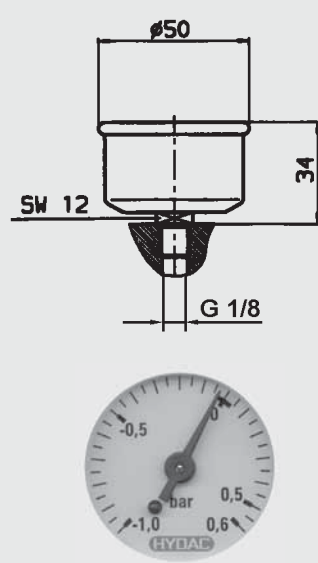
 	Type of indication	visual-analogue, scale indication	
	Weight	100 g	
	Pressure setting or indication range	-1 bar to 0.6 bar	
	Permitt. operating pressure	-0.7 to +0.4 bar continuous	
	Permitt. temperature range	-20 °C to +60 °C	
	Thread	G 1/8	
	Max. torque value	15 Nm	
	Switching type	-	
	Max. switching voltage	-	
	Electrical connection	-	
	Max. switching voltage at resistive load	-	
Switching capacity	-		
Protection class to DIN 40050	-		
Order example	VMF 0.6 K.0		

VMF x LE.x

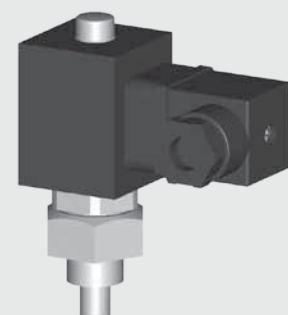
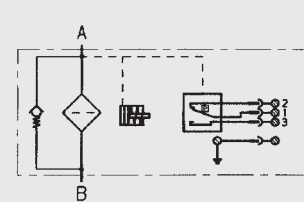
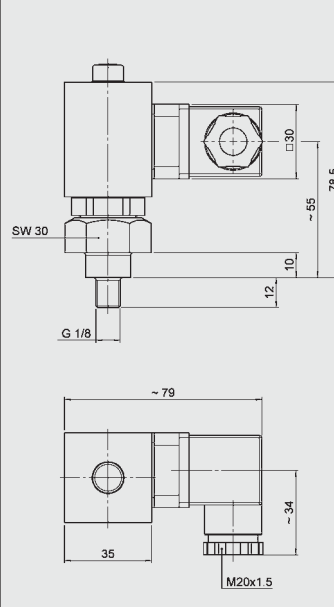
 	Type of indication	Visual, red pin and electrical switch 1 switching contact 100% of the pressure setting	
	Weight	120 g	
	Pressure setting or indication range	2 bar - 0.2 bar	
	Permitt. operating pressure	7 bar	
	Permitt. temperature range	-30 °C to +100 °C	
	Thread	G 1/8	
	Max. torque value	15 Nm	
	Switching type	N/C or N/O contacts Reed contacts (change-over contacts)	
	Max. switching voltage	115 V	
	Electrical connection	Male connection M20 Female connector to DIN 43650	
	Max. switching voltage at resistive load	15 W = max. 15 VA ~	
Switching capacity	Ohmic 1 A at 15 V = Ohmic 1 A at 15 V ~		
Protection class to DIN 40050	IP 65 (only if the connector is wired and fitted correctly)		
Order example	VMF 2 LE.1		

VR x LE.x

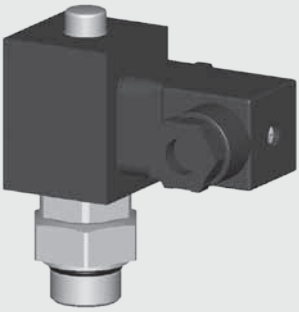
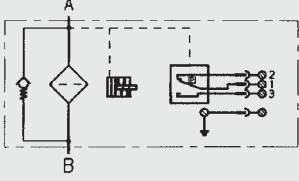
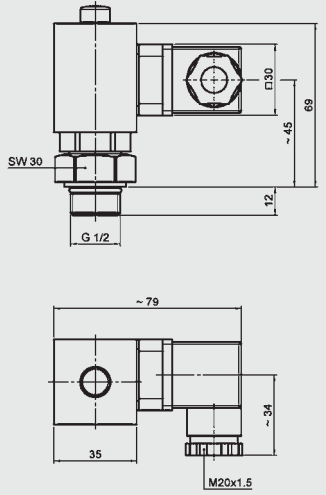
 	Type of indication	Visual, red pin and electrical switch 1 switching contact 100% of the pressure setting	
	Weight	143 g	
	Pressure setting or indication range	2 bar - 0.2 bar	
	Permitt. operating pressure	7 bar	
	Permitt. temperature range	-30 °C to +100 °C	
	Thread	G 1/2	
	Max. torque value	15 Nm	
	Switching type	N/C or N/O contacts Reed contacts (change-over contacts)	
	Max. switching voltage	115 V	
	Electrical connection	Male connection M20 Female connector to DIN 43650	
	Max. switching voltage at resistive load	15 W = max. 15 VA ~	
	Switching capacity	Ohmic 1 A at 15 V = Ohmic 1 A at 15 V ~	
	Protection class to DIN 40050	IP 65 (only if the connector is wired and fitted correctly)	
Order example	VR 2 LE.1		

VMF x LZ.x

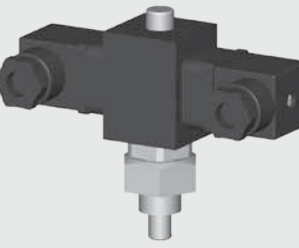
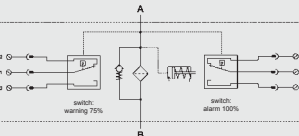
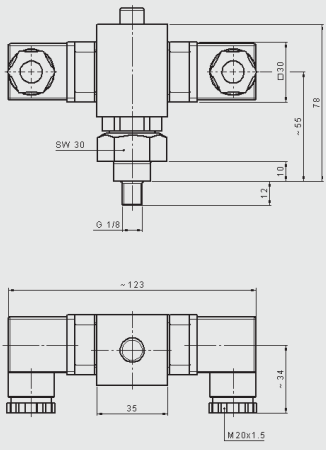
 	Type of indication	Visual, red pin and 1 electrical switching contact at 75% and at 100% of the pressure setting	
	Weight	230 g	
	Pressure setting or indication range	2 bar - 0.2 bar	
	Permitt. operating pressure	7 bar	
	Permitt. temperature range	-10 °C to +100 °C	
	Thread	G 1/8	
	Max. torque value	15 Nm	
	Switching type	N/C or N/O contacts Reed contacts (change-over contacts)	
	Max. switching voltage	115 V	
	Electrical connection	Male connection M20 Female connector to DIN 43650	
	Max. switching voltage at resistive load	15 W = max. 15 VA ~	
	Switching capacity	ohmic 1 A at 15 V = ohmic 1 A at 15 V ~	
	Protection class to DIN 40050	IP 65 (only if the connector is wired and fitted correctly)	
Order example	VMF 2 LZ.1		

VR x LZ.x

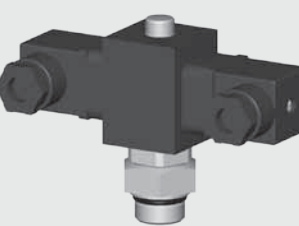
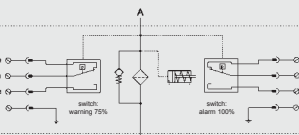
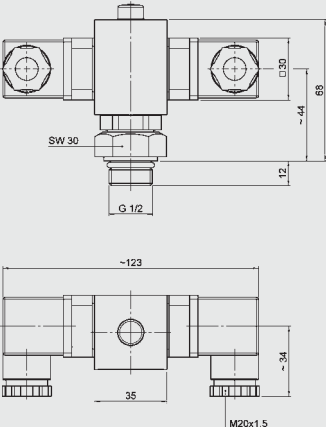
 	Type of indication	Visual, red pin and 1 electrical switching contact at 75% and at 100% of the pressure setting	
	Weight	190 g	
	Pressure setting or indication range	2 bar - 0.2 bar	
	Permitt. operating pressure	7 bar	
	Permitt. temperature range	-10 °C to +100 °C	
	Thread	G 1/2	
	Max. torque value	15 Nm	
	Switching type	N/C or N/O contacts Reed contacts (change-over contacts)	
	Max. switching voltage	115 V	
	Electrical connection	Male connection M20 Female connector to DIN 43650	
	Max. switching voltage at resistive load	15 W = max. 15 VA ~	
	Switching capacity	ohmic 1 A at 15 V = ohmic 1 A at 15 V ~	
	Protection class to DIN 40050	IP 65 (only if the connector is wired and fitted correctly)	
Order example	VR 2 LZ.1		

VMF x LZ.x /-DB

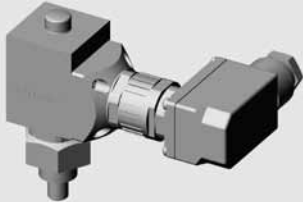
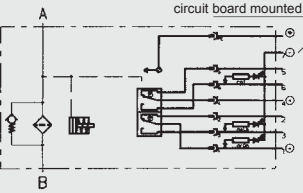
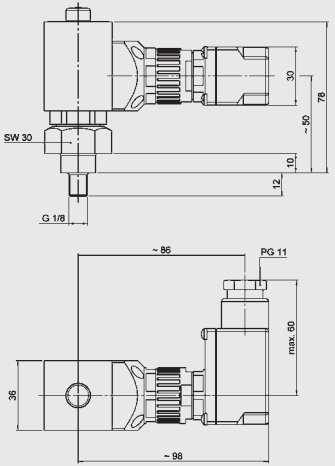
 	Type of indication	visual, red pin and 1 electrical switching contact at 75% and at 100% of the pressure setting 1 green LED constantly lit 1 yellow LED lights from 75% 1 red LED lights from 100% Δp	
	Weight	170 g	
	Pressure setting or indication range	2 bar - 0.2 bar	
	Permitt. operating pressure	7 bar	
	Permitt. temperature range	-30 °C to +100 °C	
	Thread	G 1/8	
	Max. torque value	15 Nm	
	Switching type	N/C or N/O contacts Reed contacts (change-over contacts)	
	Max. switching voltage	24 V	
	Electrical connection	Male connection PG 11 Female connector to DIN 43651	
	Max. switching voltage at resistive load	15 W = max. 15 VA ~	
	Switching capacity	Ohmic 1 A at 15 V = Ohmic 1 A at 15 V ~	
	Protection class to DIN 40050	IP 65 (only if the connector is wired and fitted correctly)	
	Order example	VMF 2 LZ.1 /-DB	

VR x LZ.x /-DB

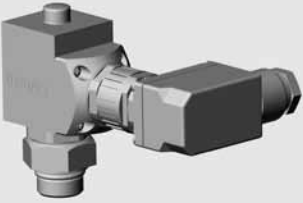
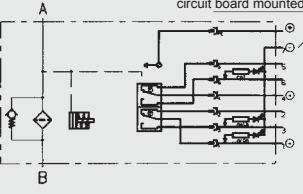
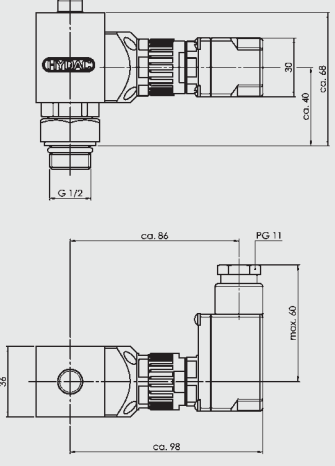
 	Type of indication	visual, red pin and 1 electrical switching contact at 75% and at 100% of the pressure setting 1 green LED constantly lit 1 yellow LED lights from 75% 1 red LED lights from 100% Δp	
	Weight	190 g	
	Pressure setting or indication range	2 bar - 0.2 bar	
	Permitt. operating pressure	7 bar	
	Permitt. temperature range	-30 °C to +100 °C	
	Thread	G 1/2	
	Max. torque value	15 Nm	
	Switching type	N/C or N/O contacts Reed contacts (change-over contacts)	
	Max. switching voltage	24 V	
	Electrical connection	Male connection PG 11 Female connector to DIN 43651	
	Max. switching voltage at resistive load	15 W = max. 15 VA ~	
	Switching capacity	Ohmic 1 A at 15 V = Ohmic 1 A at 15 V ~	
	Protection class to DIN 40050	IP 65 (only if the connector is wired and fitted correctly)	
	Order example	VR 2 LZ.1 /-DB	

VMF x LZ.x /-CN

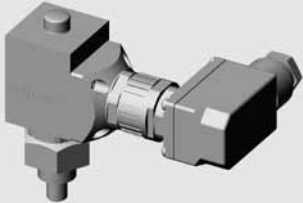
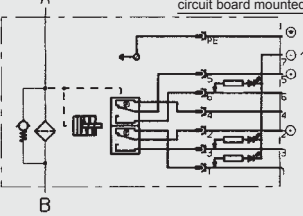
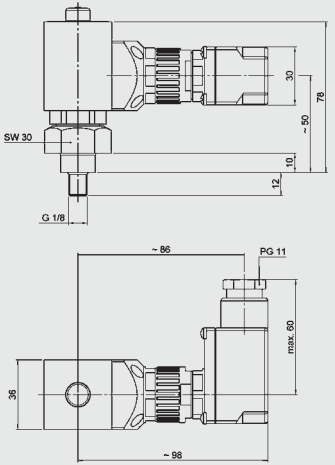
 	Type of indication	visual, red pin and 1 electrical switching contact at 75% and at 100% of the pressure setting 1 green LED goes out at 75% 1 yellow LED lights from 75% 1 red LED lights from 100% Δp	
	Weight	170 g	
	Pressure setting or indication range	2 bar - 0.2 bar	
	Permitt. operating pressure	7 bar	
	Permitt. temperature range	-30 °C to +100 °C	
	Thread	G 1/8	
	Max. torque value	15 Nm	
	Switching type	N/C or N/O contacts Reed contacts (change-over contacts)	
	Max. switching voltage	24 V	
	Electrical connection	Male connection PG 11 Female connector to DIN 43651	
	Max. switching voltage at resistive load	15 W = max. 15 VA ~	
	Switching capacity	Ohmic 1 A at 15 V = Ohmic 1 A at 15 V ~	
	Protection class to DIN 40050	IP 65 (only if the connector is wired and fitted correctly)	
	Order example	VMF 2 LZ.1 /-CN	

VR x LZ.x /-CN

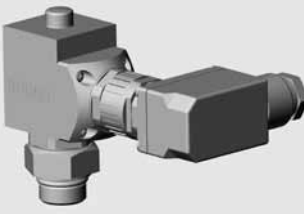
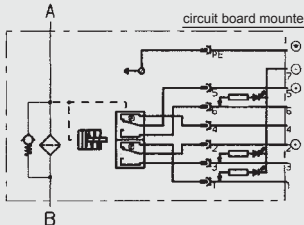
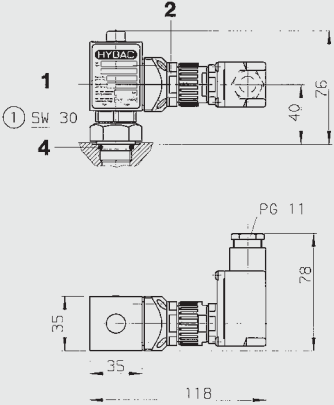
 	Type of indication	visual, red pin and 1 electrical switching contact at 75% and at 100% of the pressure setting 1 green LED goes out at 75% 1 yellow LED lights from 75% 1 red LED lights from 100% Δp	
	Weight	190 g	
	Pressure setting or indication range	2 bar - 0.2 bar	
	Permitt. operating pressure	7 bar	
	Permitt. temperature range	-30 °C to +100 °C	
	Thread	G 1/2	
	Max. torque value	15 Nm	
	Switching type	N/C or N/O contacts Reed contacts (change-over contacts)	
	Max. switching voltage	24 V	
	Electrical connection	Male connection PG 11 Female connector to DIN 43651	
	Max. switching voltage at resistive load	15 W = max. 15 VA ~	
	Switching capacity	Ohmic 1 A at 15 V = Ohmic 1 A at 15 V ~	
	Protection class to DIN 40050	IP 65 (only if the connector is wired and fitted correctly)	
	Order example	VR 2 LZ.1 /-CN	

VMF x LZ.x /-BO

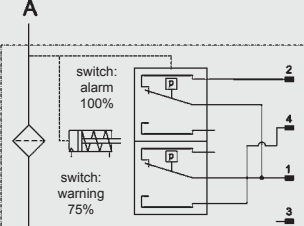
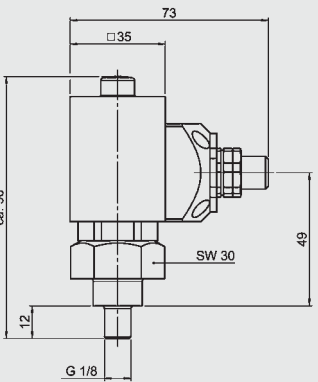
 	Type of indication	Visual, red pin and 1 electrical switching contact at 75% and at 100% of the pressure setting	
	Weight	120 g	
	Pressure setting or indication range	2 bar (or 2.5 bar) - 10%	
	Permitt. operating pressure	7 bar	
	Permitt. temperature range	-10 °C to +100 °C	
	Thread	G 1/8	
	Max. torque value	15 Nm	
	Switching type	N/O (75%) N/C (100%)	
	Max. switching voltage	24 V	
	Electrical connection	Male connection M12 x 1	
	Max. switching voltage at resistive load	15 W = max. 15 VA ~	
	Switching capacity	Ohmic 1 A at 15 V = Ohmic 1 A at 15 V ~	
	Protection class to DIN 40050	IP 65	
	Order example	VMF 2 LZ.1 /-BO	

VR x LZ.x /-BO

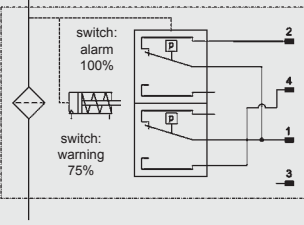
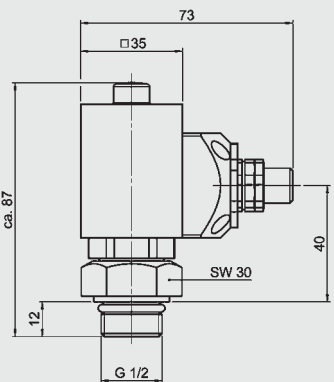
 	Type of indication	Visual, red pin and 1 electrical switching contact at 75% and at 100% of the pressure setting	
	Weight	145 g	
	Pressure setting or indication range	2 bar (or 2.5 bar) - 10%	
	Permitt. operating pressure	7 bar	
	Permitt. temperature range	-10 °C to +100 °C	
	Thread	G 1/2	
	Max. torque value	15 Nm	
	Switching type	N/O (75%) N/C (100%)	
	Max. switching voltage	24 V	
	Electrical connection	Male connection M12 x 1	
	Max. switching voltage at resistive load	15 W = max. 15 VA ~	
	Switching capacity	Ohmic 1 A at 15 V = Ohmic 1 A at 15 V ~	
	Protection class to DIN 40050	IP 65	
	Order example	VR 2 LZ.1 /-BO	

VMF x LZ.x /-AV

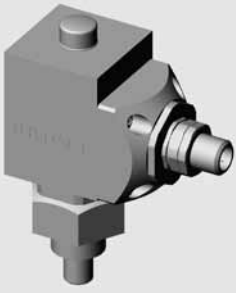
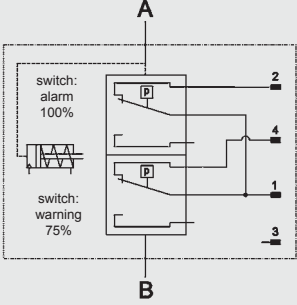
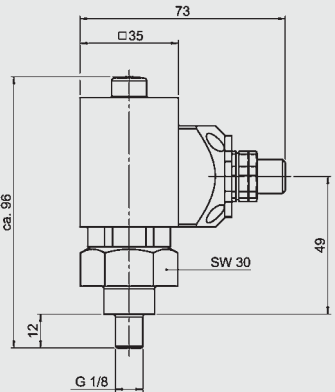
 	Type of indication	Visual, red pin and 1 electrical switching contact at 75% and at 100% of the pressure setting	
	Weight	120 g	
	Pressure setting or indication range	2 bar (or 2.5 bar) - 10%	
	Permitt. operating pressure	7 bar	
	Permitt. temperature range	-10 °C to +100 °C	
	Thread	G 1/8	
	Max. torque value	15 Nm	
	Switching type	N/C (75% and 100%)	
	Max. switching voltage	24 V	
	Electrical connection	Male connection M12 x 1	
	Max. switching voltage at resistive load	15 W = max. 15 VA ~	
	Switching capacity	Ohmic 1 A at 15 V = Ohmic 1 A at 15 V ~	
	Protection class to DIN 40050	IP 65	
	Order example	VMF 2 LZ.1 /-AV	

VR x LZ.x /-AV

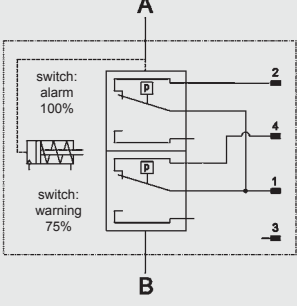
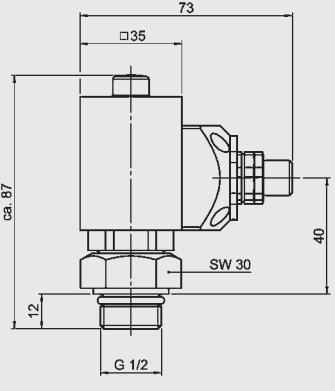
 	Type of indication	Visual, red pin and 1 electrical switching contact at 75% and at 100% of the pressure setting	
	Weight	145 g	
	Pressure setting or indication range	2 bar (or 2.5 bar) - 10%	
	Permitt. operating pressure	7 bar	
	Permitt. temperature range	-10 °C to +100 °C	
	Thread	G 1/2	
	Max. torque value	15 Nm	
	Switching type	N/C (75% and 100%)	
	Max. switching voltage	24 V	
	Electrical connection	Male connection M12 x 1	
	Max. switching voltage at resistive load	15 W = max. 15 VA ~	
	Switching capacity	Ohmic 1 A at 15 V = Ohmic 1 A at 15 V ~	
	Protection class to DIN 40050	IP 65	
	Order example	VR 2 LZ.1 /-AV	

VMF x LZ.x /-D4C

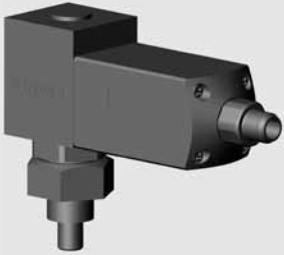
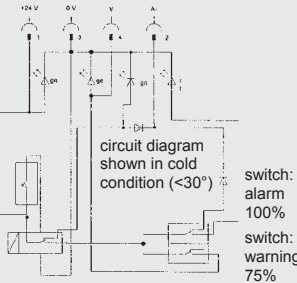
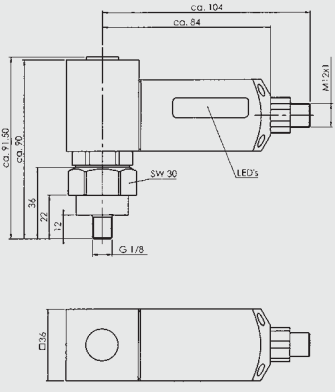
 	Type of indication	1 electrical switching contact at 75% and 100% of the pressure setting and suppression of the switching signal when operating temp. is below 30 °C. 2 green LEDs light when below 30 °C 1 green LED lights from 30 °C 1 yellow LED lights from 75% 1 red LED lights from 100% Δp	
	Weight	245 g	
	Pressure setting or indication range	2.5 bar - 10%	
	Permitt. operating pressure	7 bar	
	Permitt. temperature range	-10 °C to +100 °C	
	Thread	G 1/8	
	Max. torque value	15 Nm	
	Switching type	N/O (75%) N/C (100%)	
	Max. switching voltage	24 V	
	Electrical connection	Male connection M12 x 1	
	Max. switching voltage at resistive load	15 W = max. 15 VA ~	
	Switching capacity	Ohmic 1 A at 15 V = Ohmic 1 A at 15 V ~	
	Protection class to DIN 40050	IP 65	
	Order example	VMF 2 LZ.1 /-D4C	

VR x LZ.x /-D4C

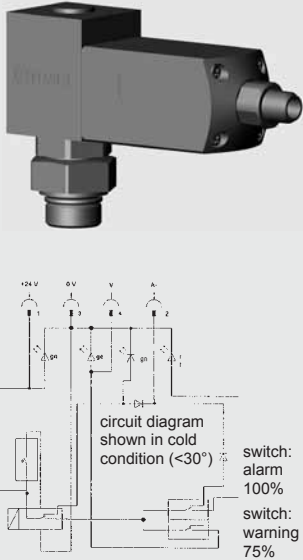
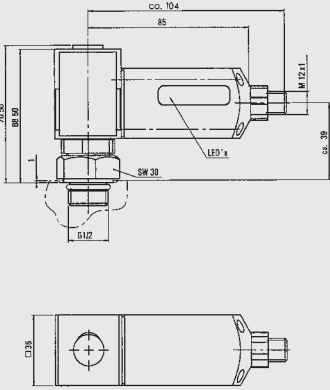
 <p>switch: alarm 100%</p> <p>switch: warning 75%</p>	<p>Type of indication</p> <p>1 electrical switching contact at 75% and at 100% of the pressure setting and suppression of the switching signal up to approx. 30 °C. 2 green LEDs light when below 30 °C 1 green LED lights from 30 °C 1 yellow LED lights from 75% 1 red LED lights from 100% Δp</p> <p>Weight: 205 g</p> <p>Pressure setting or indication range: 2.5 bar - 10%</p> <p>Permitt. operating pressure: 7 bar</p> <p>Permitt. temperature range: -10 °C to +100 °C</p> <p>Thread: G 1/2</p> <p>Max. torque value: 15 Nm</p> <p>Switching type: N/O (75%) N/C (100%)</p> <p>Max. switching voltage: 24 V</p> <p>Electrical connection: Male connection M12 x 1</p> <p>Max. switching voltage at resistive load: 15 W = max. 15 VA ~</p> <p>Switching capacity: Ohmic 1 A at 15 V = Ohmic 1 A at 15 V ~</p> <p>Protection class to DIN 40050: IP 65</p> <p>Order example: VR 2 LZ.1 /-D4C</p>	
---	--	---

VMF x LZ.x /-BO-LED

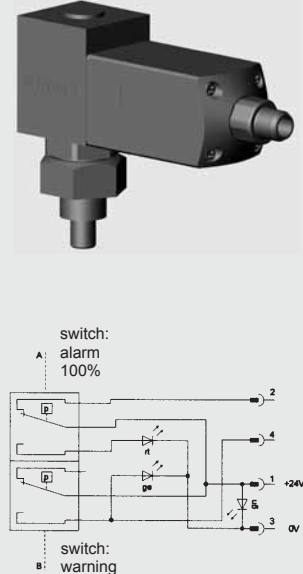
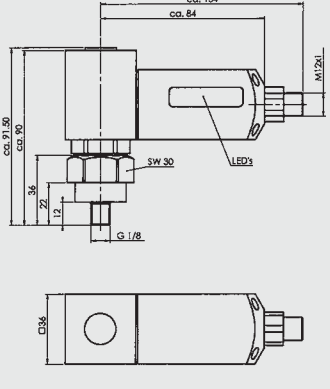
 <p>switch: alarm 100%</p> <p>switch: warning 75%</p>	<p>Type of indication</p> <p>1 electrical switching contact at 75% and at 100% of the pressure setting 1 green LED constantly lit 1 yellow LED lights from 75% 1 red LED lights from 100% Δp</p> <p>Weight: 245 g</p> <p>Pressure setting or indication range: 2.5 bar - 10%</p> <p>Permitt. operating pressure: 7 bar</p> <p>Permitt. temperature range: -10 °C to +100 °C</p> <p>Thread: G 1/8</p> <p>Max. torque value: 15 Nm</p> <p>Switching type: N/O (75%), N/C (100%)</p> <p>Max. switching voltage: 24 V</p> <p>Electrical connection: Male connection M12 x 1</p> <p>Max. switching voltage at resistive load: 15 W = max. 15 VA ~</p> <p>Switching capacity: Ohmic 1 A at 15 V = Ohmic 1 A at 15 V ~</p> <p>Protection class to DIN 40050: IP 65</p> <p>Order example: VMF 2 LZ.1 /-BO-LED</p>	
--	---	--

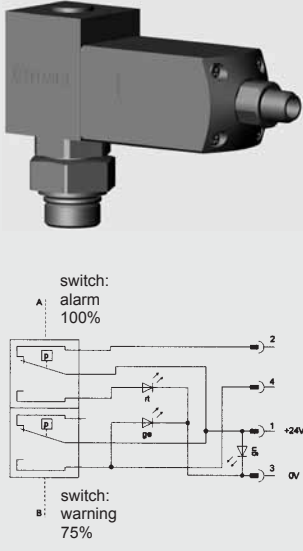
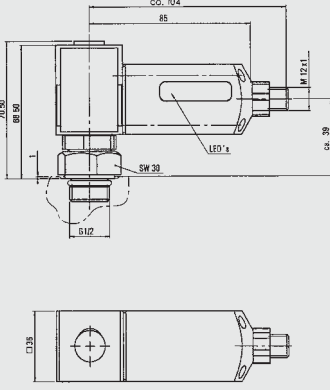

VR x LZ.x /-BO-LED

 <p>switch: alarm 100%</p> <p>switch: warning 75%</p>	<p>Type of indication</p> <p>1 electrical switching contact at 75% and at 100% of the pressure setting 1 green LED constantly lit 1 yellow LED lights from 75% 1 red LED lights from 100% Δp</p> <p>Weight: 205 g</p> <p>Pressure setting or indication range: 2.5 bar - 10%</p> <p>Permitt. operating pressure: 7 bar</p> <p>Permitt. temperature range: -10 °C to +100 °C</p> <p>Thread: G 1/2</p> <p>Max. torque value: 15 Nm</p> <p>Switching type: N/O (75%), N/C (100%)</p> <p>Max. switching voltage: 24 V</p> <p>Electrical connection: Male connection M12 x 1</p> <p>Max. switching voltage at resistive load: 15 W = max. 15 VA ~</p> <p>Switching capacity: Ohmic 1 A at 15 V = Ohmic 1 A at 15 V ~</p> <p>Protection class to DIN 40050: IP 65</p> <p>Order example: VR 2 LZ.1 /-BO-LED</p>	
---	--	---

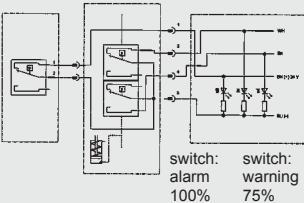
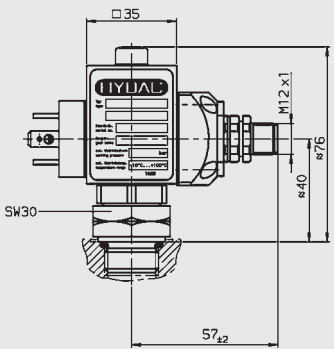

VR x LZ.x /-GM

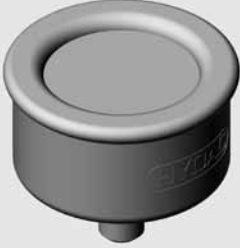
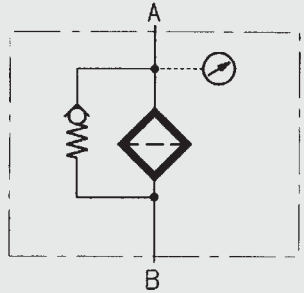
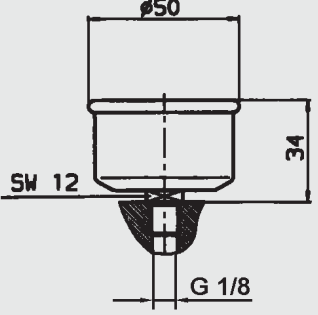
 	Type of indication	Visual, red pin and 1 electrical switching contact at 75% and at 100% of the pressure setting Indicator function possible in conjunction with the "No element" indicator	
	Weight	290 g	
	Pressure setting or indication range	2.5 bar - 10%	
	Permitt. operating pressure	7 bar	
	Permitt. temperature range	-10 °C to +100 °C	
	Thread	G 1/2	
	Max. torque value	15 Nm	
	Switching type	-	
	Max. switching voltage	24 V	
	Electrical connection	Male connection M12 x 1	
	Max. switching voltage at resistive load	15 W = max. 15 VA ~	
	Switching capacity	Ohmic 1 A at 15 V = Ohmic 1 A at 15 V ~	
	Protection class to DIN 40050	IP 65	
	Order example	VR 2 LZ.1 /-GM	

VMF x R.x

 	Type of indication	visual-analogue, scale indication	 
	Weight	80 g	
	Pressure setting or indication range	0 to 10 bar	
	Permitt. operating pressure	7 bar continuous	
	Permitt. temperature range	-20 °C to +60 °C	
	Thread	G 1/8	
	Max. torque value	15 Nm	
	Switching type	-	
	Max. switching voltage	-	
	Electrical connection	-	
	Max. switching voltage at resistive load	-	
	Switching capacity	-	
	Protection class to DIN 40050	-	
	Order example	VMF 2 R.0	

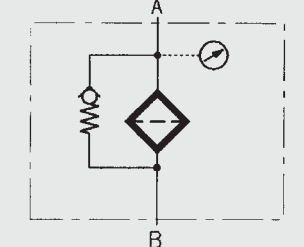
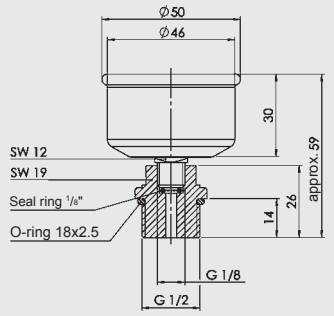
VR x R.x

 	Type of indication	visual-analogue, scale indication	 
	Weight	140 g	
	Pressure setting or indication range	0 to 10 bar	
	Permitt. operating pressure	7 bar continuous	
	Permitt. temperature range	-20 °C to +60 °C	
	Thread	G 1/2	
	Max. torque value	30 Nm	
	Switching type	-	
	Max. switching voltage	-	
	Electrical connection	-	
	Max. switching voltage at resistive load	-	
	Switching capacity	-	
	Protection class to DIN 40050	-	
	Order example	VR 2 R.0	

3.3 DIFFERENTIAL PRESSURE INDICATORS

VM x B.x

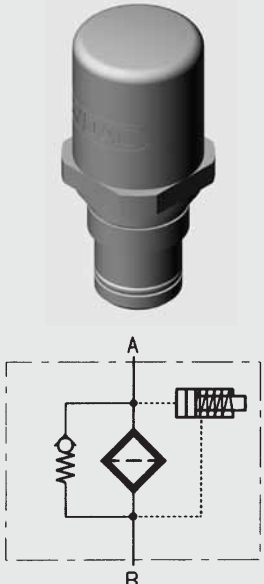
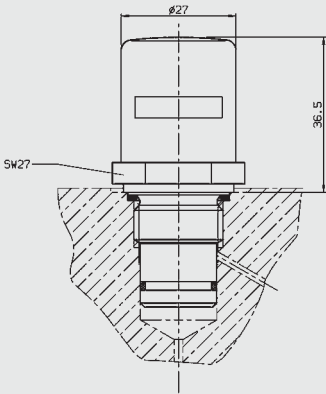
	Type of indication	Visual, red/green band Automatic reset	
	Weight	55 g	
	Pressure setting or indication range	2 bar - 10% 5 bar - 10% 8 bar ± 10%	
	Permitt. operating pressure	210 bar	
	Permitt. temperature range	-30 °C to +100 °C	
	Thread	G 1/2	
	Max. torque value	33 Nm	
	Switching type	-	
	Max. switching voltage	-	
	Electrical connection	-	
	Max. switching voltage at resistive load	-	
	Switching capacity	-	
	Protection class to DIN 40050	-	
	Order example	VM 5 B.1	

VD x B.x

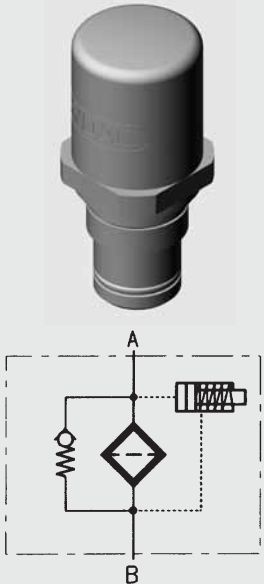
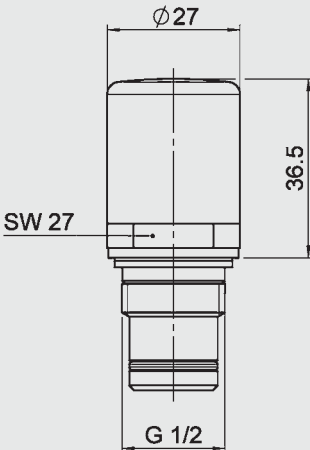
	Type of indication	Visual, red/green band Automatic reset	
	Weight	110 g	
	Pressure setting or indication range	2 bar - 10% 5 bar - 10% 8 bar ± 10%	
	Permitt. operating pressure	420 bar	
	Permitt. temperature range	-30 °C to +100 °C	
	Thread	G 1/2	
	Max. torque value	100 Nm	
	Switching type	-	
	Max. switching voltage	-	
	Electrical connection	-	
	Max. switching voltage at resistive load	-	
	Switching capacity	-	
	Protection class to DIN 40050	-	
	Order example	VD 5 B.1	

VM x BM.x

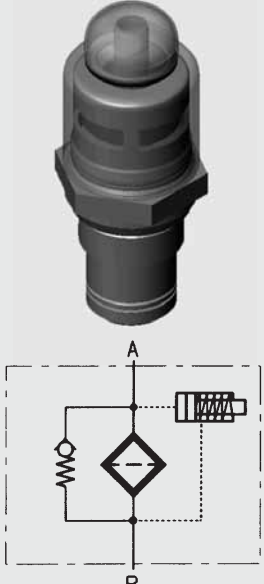
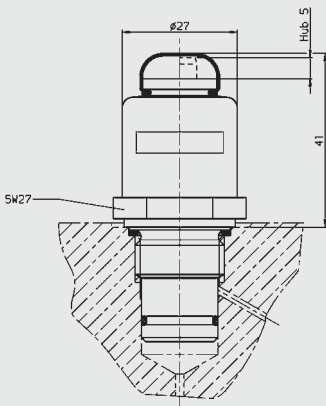
	Type of indication	Visual, red/green band Manual reset	
	Weight	55 g	
	Pressure setting or indication range	2 bar - 10% 5 bar - 10% 8 bar ± 10%	
	Permitt. operating pressure	210 bar	
	Permitt. temperature range	-30 °C to +100 °C	
	Thread	G 1/2	
	Max. torque value	33 Nm	
	Switching type	-	
	Max. switching voltage	-	
	Electrical connection	-	
	Max. switching voltage at resistive load	-	
	Switching capacity	-	
	Protection class to DIN 40050	-	
	Order example	VM 5 BM.1	

VD x BM.x

	Type of indication	Visual, red/green band Manual reset	
	Weight	110 g	
	Pressure setting or indication range	2 bar - 10 % 5 bar - 10% 8 bar ± 10%	
	Permitt. operating pressure	420 bar	
	Permitt. temperature range	-30 °C to +100 °C	
	Thread	G 1/2	
	Max. torque	100 Nm	
	Switching type	-	
	Max. switching voltage	-	
	Electrical connection	-	
	Max. switching voltage at resistive load	-	
	Switching capacity	-	
	Protect. class to DIN 40050	-	
Order example	VD 5 BM.1		

VM x C.x

	Type of indication	electrical switch	
	Weight	120 g	
	Pressure setting or indication range	2 bar - 10% 5 bar - 10% 8 bar ± 10%	
	Permitt. operating pressure	210 bar	
	Permitt. temperature range	-30 °C to +100 °C	
	Thread	G 1/2	
	Max. torque value	33 Nm	
	Switching type	N/C or N/O (change-over contacts)	
	Max. switching voltage	230 V	
	Electrical connection	Male connection M20 Female connector to DIN 43650	
	Max. switching voltage at resistive load	60 W = 100 VA ~	
	Switching capacity ¹⁾	Ohmic 3 A at 24 V = Ohmic 0.03 to 5 A at max. 230 V ~	
	Protection class to DIN 40050	IP 65 (only if the connector is wired and fitted correctly)	
Order example	VM 5 C.0		

VD x C.x

	Type of indication	electrical switch	
	Weight	220 g	
	Pressure setting or indication range	5 bar - 10% 8 bar ± 10%	
	Permitt. operating pressure	420 bar	
	Permitt. temperature range	-30 °C to +100 °C	
	Thread	G 1/2	
	Max. torque	100 Nm	
	Switching type	N/C or N/O (change-over contacts)	
	Max. switching voltage	230 V	
	Electrical connection	Male connection M20 Female connector to DIN 43650	
	Max. switching voltage at resistive load	60 W = 100 VA ~	
	Switching capacity ¹⁾	Ohmic 3 A at 24 V = Ohmic 0.03 to 5 A at max. 230 V ~	
	Protection class to DIN 40050	IP 65 (only if the connector is wired and fitted correctly)	
Order example	VD 5 C.0		

¹⁾ Required amperage > 20 mA; for lower amperages, order "-SO135" indicators (see Supplementary details).

VM x D.x /-L...

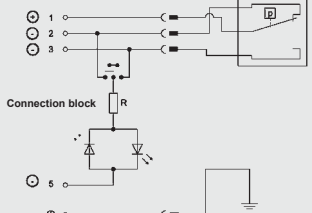
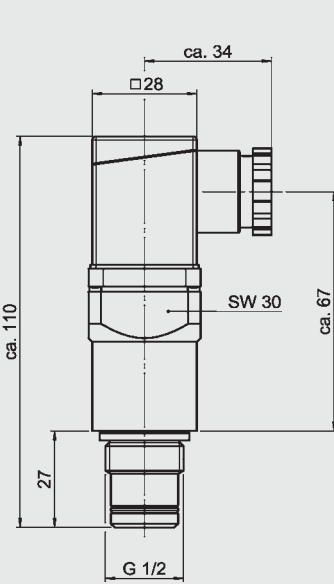
 	Type of indication	visual indicator and electrical switch	
	Weight	150 g	
	Pressure setting or indication range	2 bar - 10% 5 bar - 10% 8 bar ± 10%	
	Permitt. operating pressure	210 bar	
	Permitt. temperature range	-30 °C to +100 °C	
	Thread	G 1/2	
	Max. torque value	33 Nm	
	Switching type	N/C or N/O (change-over contacts)	
	Max. switching voltage	24, 48, 110, 230 V depending on the type of light insert	
	Electrical connection	Male connection M20 Female connector to DIN 43650	
	Max. switching voltage at resistive load	60 W = 100 VA ~	
	Switching capacity ¹⁾	Ohmic 3 A at 24 V = Ohmic 0.03 to 5 A at max. 230 V ~	

VD x D.x /-L...

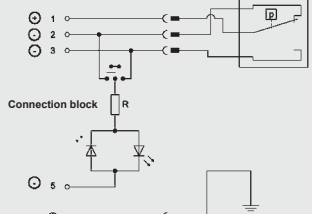
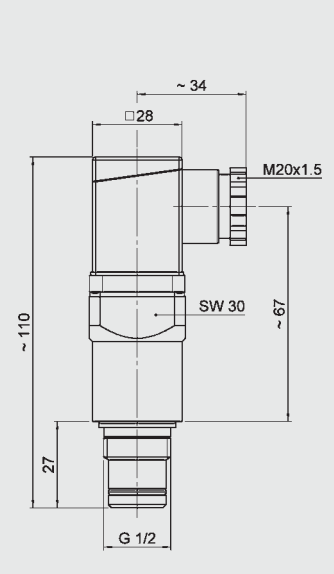
 	Type of indication	visual indicator and electrical switch	
	Weight	250 g	
	Pressure setting or indication range	2 bar -10% 5 bar - 10% 8 bar ± 10%	
	Permitt. operating pressure	420 bar	
	Permitt. temperature range	-30 °C to +100 °C	
	Thread	G 1/2	
	Max. torque value	100 Nm	
	Switching type	N/C or N/O (change-over contacts)	
	Max. switching voltage	24, 48, 110, 230 V depending on the type of light insert	
	Electrical connection	Male connection M20 Female connector to DIN 43650	
	Max. switching voltage at resistive load	60 W = 100 VA ~	
	Switching capacity ¹⁾	Ohmic 3 A at 24 V = Ohmic 0.03 to 5 A at max. 230 V ~	

VM x D.x /-LED

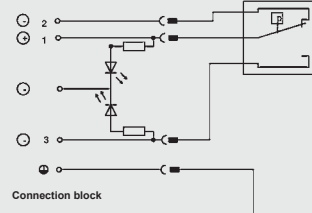
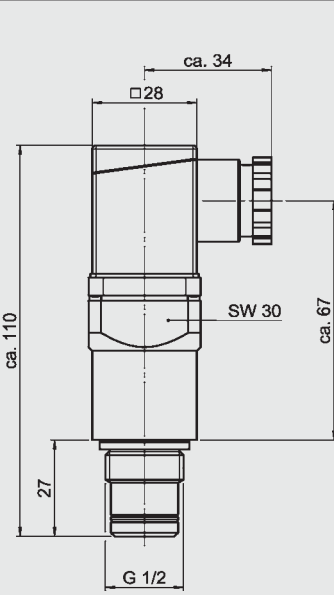
 	Type of indication	visual indicator and electrical switch	
	Weight	150 g	
	Pressure setting or indication range	2 bar - 10% 5 bar - 10% 8 bar ± 10%	
	Permitt. operating pressure	210 bar	
	Permitt. temperature range	-30 °C to +100 °C	
	Thread	G 1/2	
	Max. torque value	33 Nm	
	Switching type	N/C or N/O (change-over contacts)	
	Max. switching voltage	24 V	
	Electrical connection	Male connection M20 Female connector to DIN 43650	
	Max. switching voltage at resistive load	60 W = 100 VA ~	
	Switching capacity ¹⁾	ohmic 3 A at 24 V =	

¹⁾ Required amperage > 20 mA; for lower amperages, order "-SO135" indicators (see Supplementary details).

VD x D.x /-LED

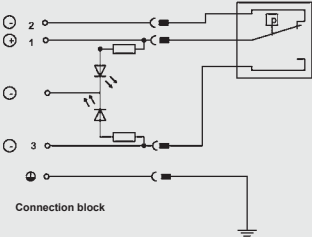
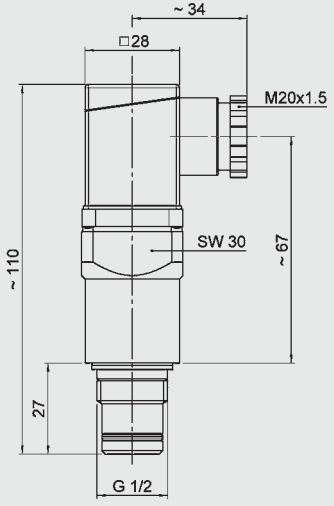
 	Type of indication	visual indicator and electrical switch	
	Weight	250 g	
	Pressure setting or indication range	2 bar - 10% 5 bar - 10% 8 bar ± 10%	
	Permitt. operating pressure	420 bar	
	Permitt. temperature range	-30 °C to +100 °C	
	Thread	G 1/2	
	Max. torque	100 Nm	
	Switching type	N/C or N/O (change-over contacts)	
	Max. switching voltage	24 V	
	Electrical connection	Male connection M20 Female connector to DIN 43650	
	Max. switching voltage at resistive load	60 W = 100 VA ~	
	Switching capacity ¹⁾	ohmic 3 A at 24 V =	
	Protection class to DIN 40050	IP 65 (only if the connector is wired and fitted correctly)	
	Order example	VD 5 D.0 /-LED	

VD x GC.x

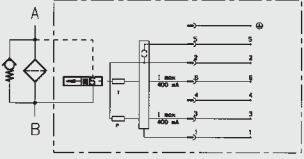
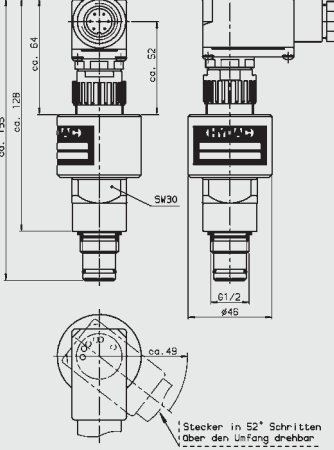
 	Type of indication	Electronic/analogue (4-20 mA or 1-10 V) 1 electrical switching contact at 75% and at 100% of the pressure setting Analogue signal up to 20% of the pressure setting constant 4mA or 1 V	 <p>Stecker in 52° Schritten über den Umfang drehbar</p>
	Weight	400 g	
	Pressure setting or indication range	2 bar - 10% 5 bar - 10% 8 bar - 10%	
	Permitt. operating pressure	420 bar	
	Permitt. temperature range	-30 °C to +80 °C	
	Thread	G 1/2	
	Max. torque value	100 Nm	
	Switching type	N/C or N/O, electronic PNP positive switching (factory setting)	
	Max. switching voltage	operating voltage 20 - 30 V DC	
	Electrical connection	7 pole plug to DIN 43651; PG 11	
	Max. switching voltage at resistive load	12 W	
	Switching capacity	ohmic 0.4 A at 30 V =	
	Protection class to DIN 40050	IP 65 (only if the connector is wired and fitted correctly)	
	Order example	VD 5 GC.0 /-LED-SQ-123	

VL x GW.x

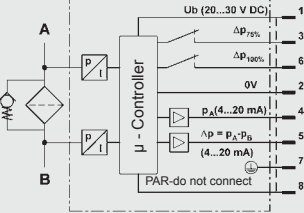
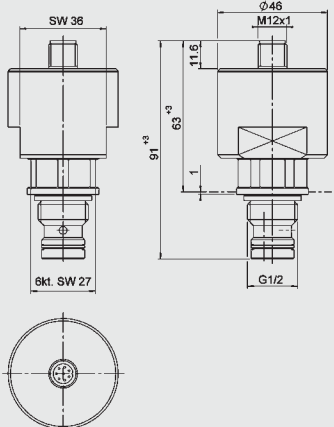
 	Type of indication	Electronic/analogue (4-20 mA) for condition monitoring filters incl. bypass monitoring. 1 switching contact at 75% and at 100% of the pressure setting	
	Weight	157 g	
	Pressure setting p (switching contact 100%)	2 bar ± 5% 3 bar ± 5% 5 bar ± 5%	
	Indication range Δp	0 - 5 bar 0 - 5 bar 0 - 8 bar	
	Indication range "pressure before filter"	25 bar	
	Type of switching	electronic switch, PNP positive switching	
	switching outputs Δp	N/O or N/C contacts (factory setting)	
	Output load	400 mA	
	Max. switching voltage / operating voltage	20...30V DC	
	Analogue outputs "press. before filter" & Δp	4...20 mA (max. load resistance 600Ω)	
	Electrical connection	M12 x 1 / 8 pole	
	Protection class to DIN 40050	IP 65	
	Permitt. operating pressure	25 bar	
	Permitt. temperature range	-40 °C to +85 °C	
	Thread	G 1/2	
	Max. torque	33 Nm	
	Order example	VL 5 GW.0 /-V-123	

¹⁾ Required amperage > 20 mA; for lower amperages, order "-SO135" indicators (see Supplementary details).

VD x LE.x

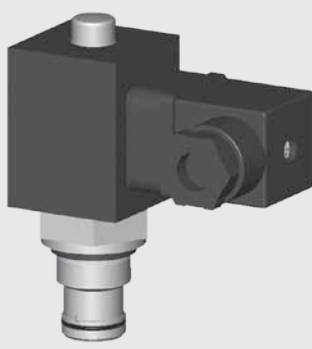
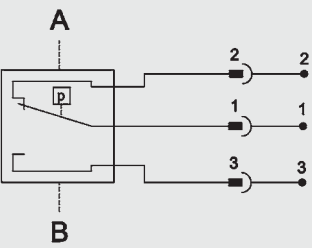
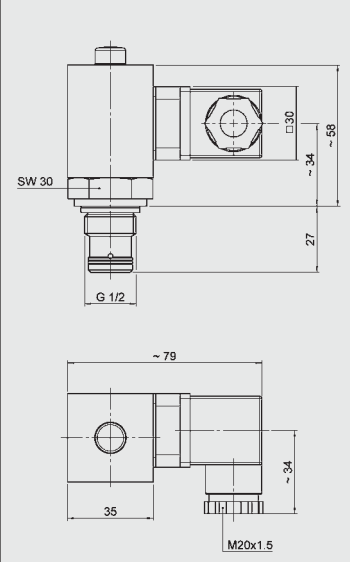
 <p>A</p>  <p>B</p>	Type of indication	visual, red pin and electrical switch 1 switching contact at 100% of the pressure setting	
	Weight	198 g	
	Pressure setting or indication range	2 bar - 10% 5 bar - 10% 8 bar - 10%	
	Permitt. operating pressure	420 bar	
	Permitt. temperature range	-30 °C to +100 °C	
	Thread	G 1/2	
	Max. torque	50 Nm	
	Switching type	N/C or N/O contacts Reed contacts (change-over contacts)	
	Max. switching voltage	115 V	
	Electrical connection	Male connection M20 Female connector to DIN 43650	
	Max. switching voltage at resistive load	15 W = max. 15 VA ~	
	Switching capacity	Ohmic 1 A at 15 V = Ohmic 1 A at 15 V ~	
	Protection class to DIN 40050	IP 65 (only if the connector is wired and fitted correctly)	
	Order example	VD 5 LE.1	

VD x LZ.x

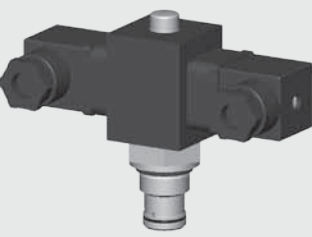
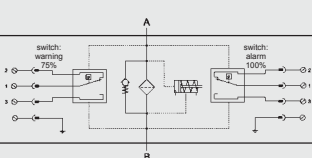
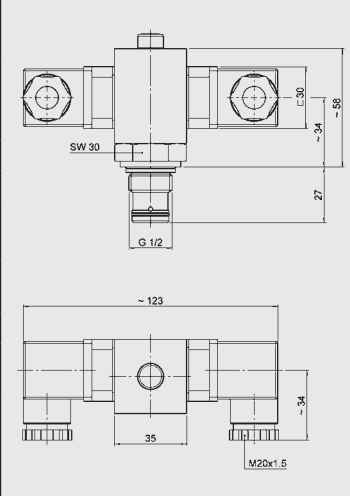
 <p>A</p>  <p>B</p>	Type of indication	Visual, red pin and 1 electrical switching contact at 75% and at 100% of the pressure setting	
	Weight	240 g	
	Pressure setting or indication range	2 bar - 10% 5 bar - 10% 8 bar - 10%	
	Permitt. operating pressure	420 bar	
	Permitt. temperature range	-30 °C to +100 °C	
	Thread	G 1/2	
	Max. torque value	50 Nm	
	Switching type	N/C or N/O contacts Reed contacts (change-over contacts)	
	Max. switching voltage	115 V	
	Electrical connection	Male connection M20 Female connector to DIN 43650	
	Max. switching voltage at resistive load	15 W = max. 15 VA ~	
	Switching capacity	ohmic 1 A at 15 V = ohmic 1 A at 15 V ~	
	Protection class to DIN 40050	IP 65 (only if the connector is wired and fitted correctly)	
	Order example	VD 5 LZ.1	

VD x LZ.x /-DB

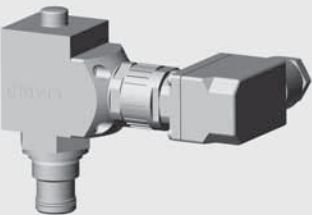
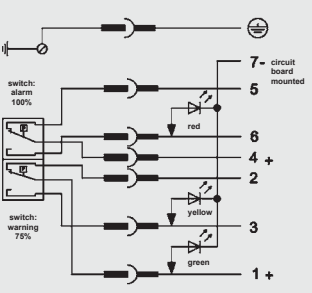
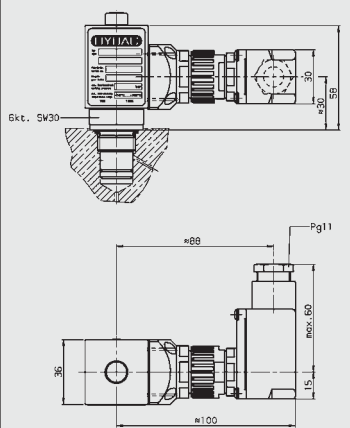
 <p>A</p>  <p>B</p>	Type of indication	visual, red pin and 1 electrical switching contact at 75% and at 100% of the pressure setting 1 green LED constantly lit 1 yellow LED lights from 75% 1 red LED lights from 100% Δp	
	Weight	245 g	
	Pressure setting or indication range	2 bar - 10% 5 bar - 10% 8 bar - 10%	
	Permitt. operating pressure	420 bar	
	Permitt. temperature range	-30 °C to +100 °C	
	Thread	G 1/2	
	Max. torque value	50 Nm	
	Switching type	N/C or N/O contacts Reed contacts (change-over contacts)	
	Max. switching voltage	24 V	
	Electrical connection	Male connection PG 11 Female connector to DIN 43651	
	Max. switching voltage at resistive load	15 W = max. 15 VA ~	
	Switching capacity	Ohmic 1 A at 15 V = Ohmic 1 A at 15 V ~	
	Protection class to DIN 40050	IP 65 (only if the connector is wired and fitted correctly)	
	Order example	VD 5 LZ.1 /-DB	

VD x LZ.x /-CN

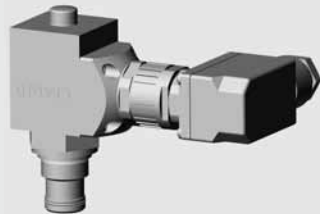
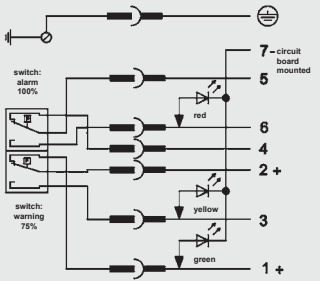
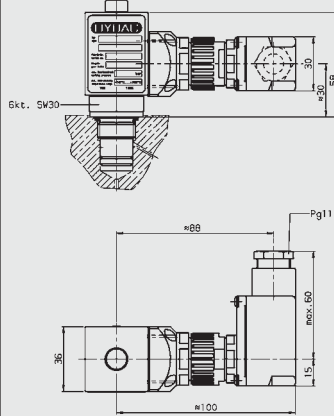
 	Type of indication	visual, red pin and 1 electrical switching contact at 75% and at 100% of the pressure setting 1 green LED goes out at 75% 1 yellow LED lights from 75% 1 red LED lights from 100% Δp	
	Weight	245 g	
	Pressure setting or indication range	2 bar - 10% 5 bar - 10% 8 bar - 10%	
	Permitt. operating pressure	420 bar	
	Permitt. temperature range	-30 °C to +100 °C	
	Thread	G 1/2	
	Max. torque value	50 Nm	
	Switching type	N/C or N/O contacts Reed contacts (change-over contacts)	
	Max. switching voltage	24 V	
	Electrical connection	Male connection PG 11 Female connector to DIN 43651	
	Max. switching voltage at resistive load	15 W = max. 15 VA ~	
	Switching capacity	Ohmic 1 A at 15 V = Ohmic 1 A at 15 V ~	
	Protection class to DIN 40050	IP 65 (only if the connector is wired and fitted correctly)	
	Order example	VD 5 LZ.1 /-CN	

VD x LZ.x /-BO

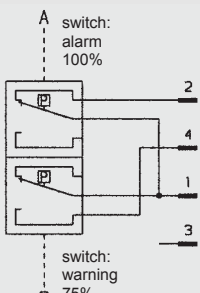
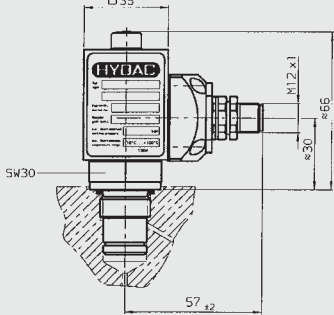
 	Type of indication	Visual, red pin and 1 electrical switching contact at 75% and at 100% of the pressure setting	
	Weight	197 g	
	Pressure setting or indication range	2 bar - 10% 5 bar - 10% 8 bar - 10%	
	Permitt. operating pressure	420 bar	
	Permitt. temperature range	-10 °C to +100 °C	
	Thread	G 1/2	
	Max. torque value	50 Nm	
	Switching type	N/O (75%) N/C (100%)	
	Max. switching voltage	24 V	
	Electrical connection	Male connection M12 x 1	
	Max. switching voltage at resistive load	15 W = max. 15 VA ~	
	Switching capacity	Ohmic 1 A at 15 V = Ohmic 1 A at 15 V ~	
	Protection class to DIN 40050	IP 65	
	Order example	VD 5 LZ.1 /-BO	

VD x LZ.x /-AV

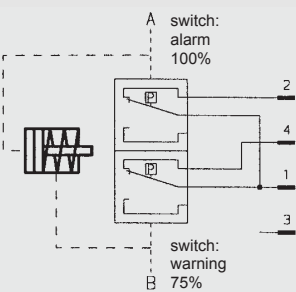
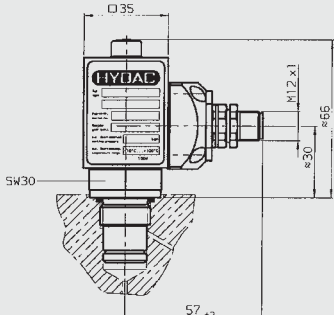
 	Type of indication	Visual, red pin and 1 electrical switching contact at 75% and at 100% of the pressure setting	
	Weight	197 g	
	Pressure setting or indication range	2 bar - 10% 5 bar - 10% 8 bar - 10%	
	Permitt. operating pressure	420 bar	
	Permitt. temperature range	-10 °C to +100 °C	
	Thread	G 1/2	
	Max. torque value	50 Nm	
	Switching type	N/C (75% and 100%)	
	Max. switching voltage	24 V	
	Electrical connection	Male connection M12 x 1	
	Max. switching voltage at resistive load	15 W = max. 15 VA ~	
	Switching capacity	Ohmic 1 A at 15 V = Ohmic 1 A at 15 V ~	
	Protection class to DIN 40050	IP 65	
	Order example	VD 5 LZ.1 /-AV	

V02 x VE.x

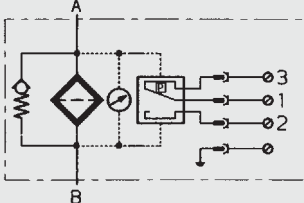
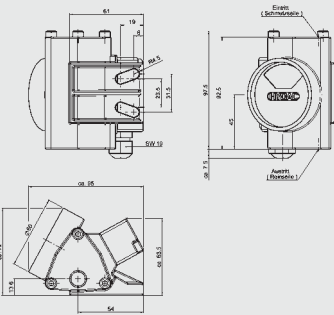
 	Type of indication	Visual/analogue indicator and electrical switching contact 100% of the pressure setting		
	Weight	640 g		
	Pressure setting or indication range	0.8 bar ± 10% 2.0 bar ± 10% 4.3 bar ± 10%		
	Permitt. operating pressure	100 bar		
	Permitt. temperature range	-30 °C to +100 °C		
	Thread	G 1/4		
	Max. torque value	-		
	Switching type	100% change-over contact		
	Max. switching voltage	250 V		
	Electrical connection	threaded connection M16 x 1.5		
	Max. switching voltage at resistive load	100% contact 30 W = 60 VA ~		
	Switching capacity	Ohmic 2.5 A at 24 V = Ohmic 1 A at 220 V ~		
	Protection class to DIN 40050	IP 65		
	Order example	V02 2 VE.0		

V02 x VZ.x

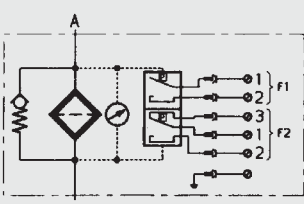
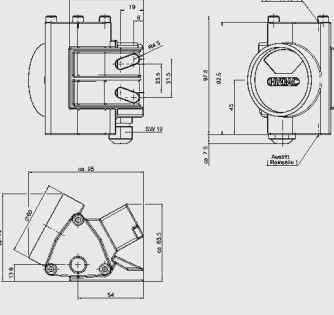
 	Type of indication	Visual/analogue indicator and 1 electrical switching contact at 75% and 100% of the pressure setting		
	Weight	650 g		
	Pressure setting or indication range	0.8 bar ± 10% 2.0 bar ± 10% 4.3 bar ± 10%		
	Permitt. operating pressure	100 bar		
	Permitt. temperature range	-30 °C to +100 °C		
	Thread	G 1/4		
	Max. torque value	-		
	Switching type	75% - N/O contact 100% - change-over contact		
	Max. switching voltage	250 V		
	Electrical connection	threaded connection M16 x 1.5		
	Max. switching voltage at resistive load	75% contact 120 W = 120 VA ~	100% contact 30 W = 60 VA ~	
	Switching capacity	Ohmic 2.5 A at 24 V = Ohmic 1 A at 220 V ~		
	Protection class to DIN 40050	IP 65		
	Order example	V02 2 VZ.0		

3.4 MOBILE INDICATORS

3.4.1 RETURN LINE

VMF x CM.x

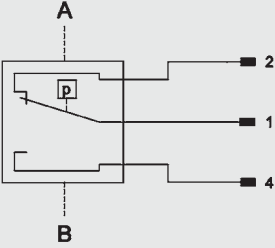
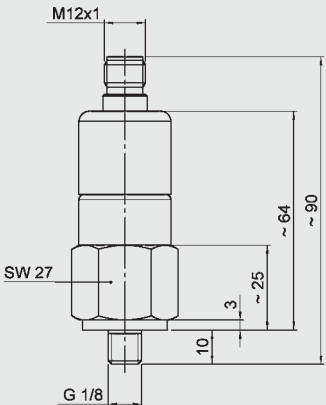
 	Type of indication	electrical switch	
	Weight	90 g	
	Pressure setting or indication range	2 bar ± 0.4 bar	
	Permitt. operating pressure	10 bar	
	Permitt. temperature range	-10 °C to +100 °C	
	Thread	G 1/8	
	Max. torque value	15 Nm	
	Switching type	N/C or N/O (change-over contacts)	
	Max. switching voltage	24V	
	Electrical connection	Male connection M12 x 1	
	Max. switching voltage at resistive load	250 W = 300 VA ~	
	Switching capacity	Ohmic 6 A at 24 V = Ohmic 0.03 to 6 A at max. 230 V ~	

VMF x FD.x (plug connection: Deutsch DT 04-2P)

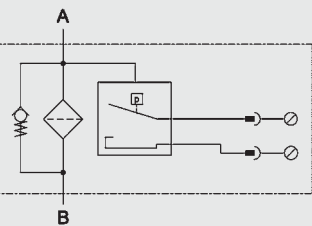
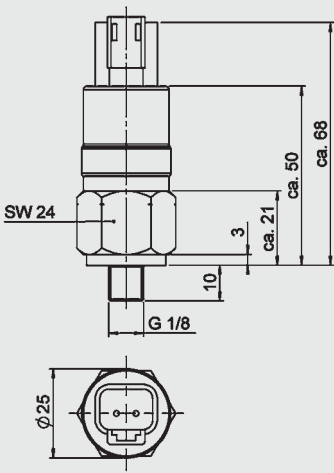
 	Type of indication	electrical switch	
	Weight	70 g	
	Pressure setting or indication range	2 bar ± 0.4 bar	
	Permitt. operating pressure	11 bar continuous	
	Permitt. temperature range	-30 °C to +100 °C	
	Thread	G 1/8	
	Max. torque	15 Nm	
	Switching type	N/O or N/C	
	Max. switching voltage	42 V	
	Electrical connection	Deutsch DT 04-2P	
	Max. switching voltage at resistive load	60 W = 100 VA ~	
	Switching capacity	Ohmic 2.5 A at 24 V = Ohmic 1 A at 220 V ~	

VR x FD.x (plug connection: Deutsch DT 04-2P)

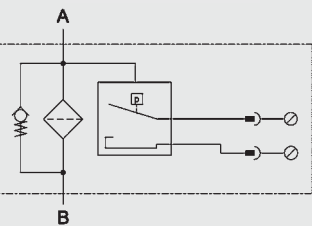
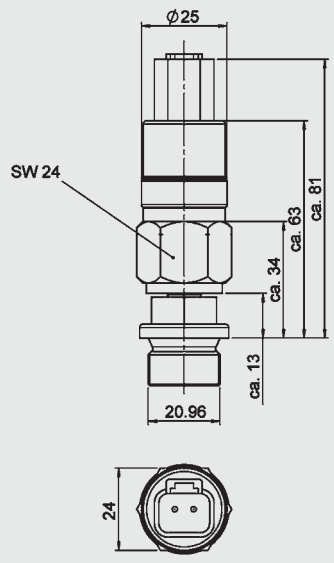
 	Type of indication	electrical switch	
	Weight	90 g	
	Pressure setting or indication range	2 bar ± 0.4 bar	
	Permitt. operating pressure	11 bar continuous	
	Permitt. temperature range	-30 °C to +100 °C	
	Thread	G 1/2	
	Max. torque	30 Nm	
	Switching type	N/O or N/C	
	Max. switching voltage	42 V	
	Electrical connection	Deutsch DT 04-2P	
	Max. switching voltage at resistive load	60 W = 100 VA ~	
	Switching capacity	Ohmic 2.5 A at 24 V = Ohmic 1 A at 220 V ~	

VR x LEM.x

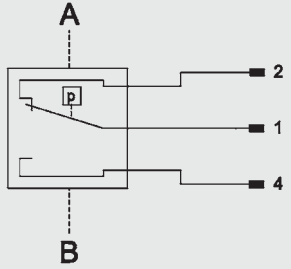
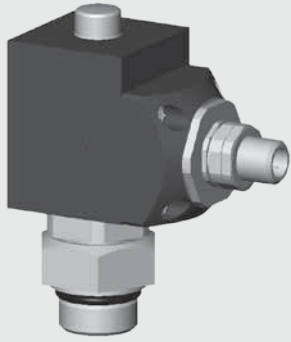

Type of indication	visual, red pin and electrical pin 1 switching contact at 100% of the pressure setting
Weight	140 g
Pressure setting or indication range	2 bar ± 0.4 bar
Permitt. operating pressure	7 bar
Permitt. temperature range	-10 °C to +100 °C
Thread	G 1/2
Max. torque value	15 Nm
Switching type	N/C or N/O contacts Reed contacts (change-over contacts)
Max. switching voltage	24V
Electrical connection	Male connection M12 x 1
Max. switching voltage at resistive load	15 W = max. 15 VA ~
Switching capacity	ohmic 1 A at 15 V = ohmic 1 A at 15 V ~
Protect. class to DIN 40050	IP 65
Order example	VR 2 LEM.1

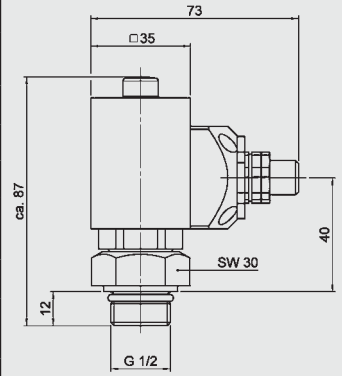

3.4.2 DIFFERENTIAL PRESSURE

VL x BF.x

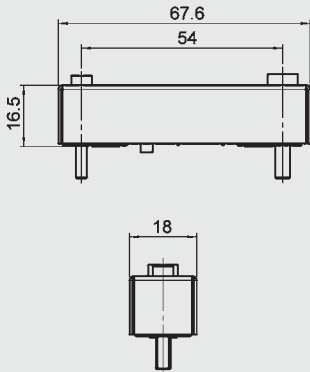
	Type of indication	visual	
	Weight	25 g	
	Pressure setting or indication range	1 bar – 10% 2.5 bar – 10%	
	Permitt. operating pressure	40 bar	
	Permitt. temperature range	-10 °C to +80 °C	
	Thread	M3; M4	
	Max. torque value	0.6 Nm	
	Switching type	-	
	Max. switching voltage	-	
	Electrical connection	-	
	Max. switching voltage at resistive load	-	
	Switching capacity	-	
	Protection class to DIN 40050	-	
	Order example	VL 2.5 BF.0	

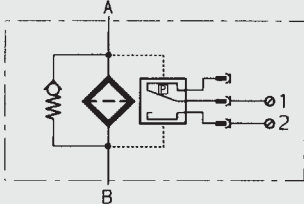
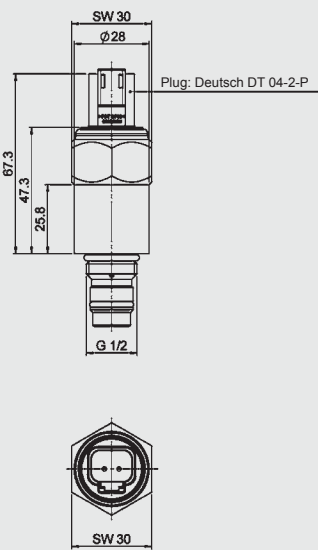

VM x CD.x (plug type: Deutsch DT 04-2P)

 	Type of indication	electrical switch	
	Weight	100 g	
	Pressure setting or indication range	2 bar - 10% 5 bar - 10% 8 bar ± 10%	
	Permitt. operating pressure	210 bar	
	Permitt. temperature range	-30 °C to +100 °C	
	Thread	G 1/2	
	Max. torque value	33 Nm	
	Switching type	N/O or N/C	
	Max. switching voltage	230 V	
	Electrical connection	-	
	Max. switching voltage at resistive load	60 W = 100 VA ~	
	Switching capacity	Ohmic 3 A at 24 V = Ohmic 0.03 to 5 A at max. 230 V ~	
	Protection class to DIN 40050	IP 67 (only if the connector is wired and fitted correctly)	
	Order example	VM 5 CD.0 /-2M0	

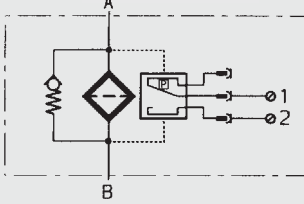
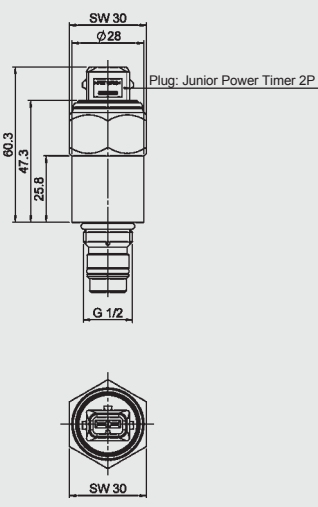
VM x CJ.x (plug type: Junior Power Timer)

 	Type of indication	electrical switch	
	Weight	100 g	
	Pressure setting or indication range	2 bar - 10% 5 bar - 10% 8 bar ± 10%	
	Permitt. operating pressure	210 bar	
	Permitt. temperature range	-30 °C to +100 °C	
	Thread	G 1/2	
	Max. torque value	33 Nm	
	Switching type	N/O or N/C	
	Max. switching voltage	230 V	
	Electrical connection	Junior Power Timer	
	Max. switching voltage at resistive load	60 W = 100 VA ~	
	Switching capacity	Ohmic 3 A at 24 V = Ohmic 0.03 to 5 A at max. 230 V ~	
	Protection class to DIN 40050	IP 54 (only if the connector is wired and fitted correctly)	
	Order example	VM 5 CJ.0 /-2M0	

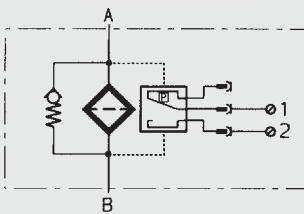
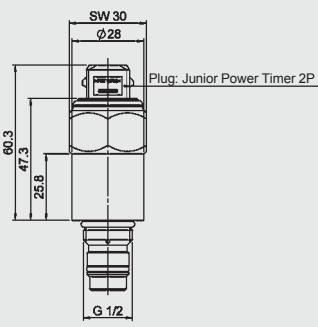
VD x CJ.x (plug type: Junior Power Timer)

 	Type of indication	electrical switch	 
	Weight	200 g	
	Pressure setting or indication range	2 bar - 10% 5 bar - 10% 8 bar ± 10%	
	Permitt. operating pressure	420 bar	
	Permitt. temperature range	-30 °C to +100 °C	
	Thread	G 1/2	
	Max. torque value	100 Nm	
	Switching type	N/O or N/C	
	Max. switching voltage	230 V	
	Electrical connection	Junior Power Timer	
	Max. switching voltage at resistive load	60 W = 100 VA ~	
	Switching capacity	Ohmic 3 A at 24 V = Ohmic 0.03 to 5 A at max. 230 V ~	
	Protection class to DIN 40050	IP 54 (only if the connector is wired and fitted correctly)	
	Order example	VD 5 CJ.0 /-2M0	

VM x CM.x

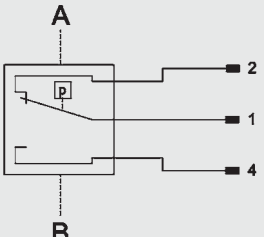
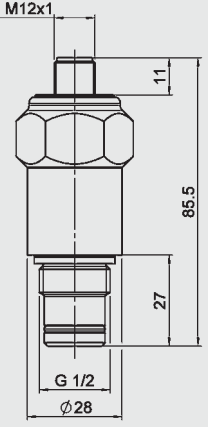
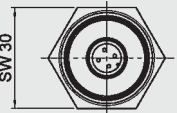
 	Type of indication	electrical switch	 
	Weight	70 g	
	Pressure setting or indication range	2 bar - 10% 5 bar - 10% 8 bar ± 10%	
	Permitt. operating pressure	210 bar	
	Permitt. temperature range	-10 °C to +100 °C	
	Thread	G 1/2	
	Max. torque value	33 Nm	
	Switching type	N/C or N/O (change-over contacts)	
	Max. switching voltage	24 V	
	Electrical connection	Male connection M12 x 1	
	Max. switching voltage at resistive load	60 W = 100 VA ~	
	Switching capacity	ohmic 2.5 A at 24 V = ohmic 2.5 A at 42 V ~	
	Protection class to DIN 40050	IP 67 (only if the connector is wired and fitted correctly)	
	Order example	VM 2 CM.0	

VM x M.x

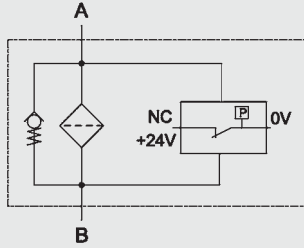
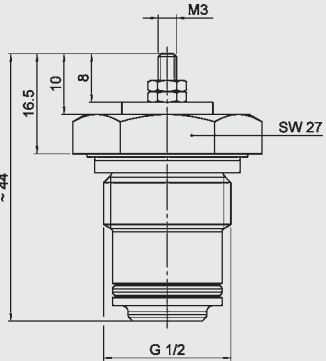
 	Type of indication	single pole (ground switching)	
	Weight	31 g	
	Pressure setting or indication range	2 bar ± 15%	
	Permitt. operating pressure	210 bar	
	Permitt. temperature range	-30 °C to +100 °C	
	Thread	G 1/2	
	Max. torque value	33 Nm	
	Switching type	N/O or N/C	
	Max. switching voltage	24V	
	Electrical connection	-	
	Max. switching voltage at resistive load	-	
	Switching capacity	-	
	Protection class to DIN 40050	terminals IP00	
	Order example	VM 2 M.0	

VD x LEM.x

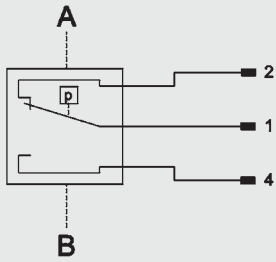
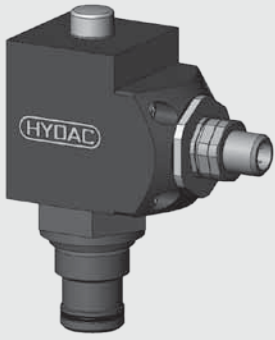

Type of indication	Visual, red pin and electrical switch 1 switching contact at 100% of the pressure setting
Weight	350 g
Pressure setting or indication range	2 bar – 10% 5 bar – 10% 8 bar – 10%
Permitt. operating pressure	420 bar
Permitt. temperature range	-10 °C to +100 °C
Thread	G 1/2
Max. torque value	50 Nm
Switching type	N/C or N/O contacts Reed contacts (change-over contacts)
Max. switching voltage	24V
Electrical connection	Male connection M12 x 1
Max. switching voltage at resistive load	15 W = max. 15 VA ~
Switching capacity	ohmic 1 A at 15 V = ohmic 1 A at 15 V ~
Protection class to DIN 40050	IP 65
Order example	VD 5 LEM.0

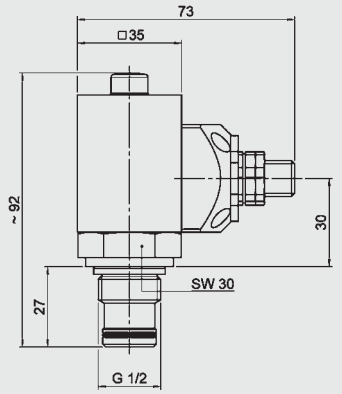

3.5 INDICATORS IN ACCORDANCE WITH ATEX DIRECTIVE

3.5.1 RETURN LINE

VR x B.x (ATEX) Can be used on aluminium filters up to Zone 1

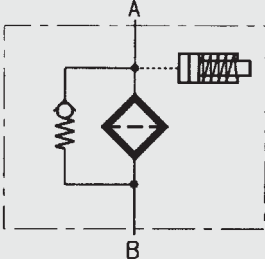
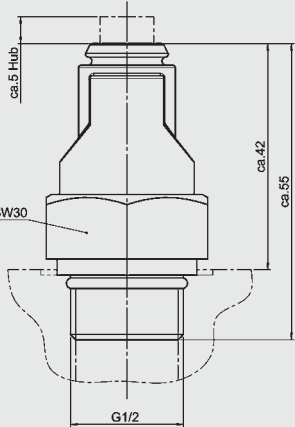
 	Type of indication	visual, red pin	
	Weight	44 g	
	Pressure setting or indication range	2 bar - 0.2 bar	
	Permitt. operating pressure	7 bar	
	Permitt. temperature range	-30 °C to +100 °C	
	Thread	G 1/2	
	Max. torque	15 Nm	
	Switching type	-	
	Max. switching voltage	-	
	Electrical connection	-	
	Max. switching voltage at resistive load	-	
	Switching capacity	-	
	Protection class to DIN 40050	-	
	Order example	VR 2 B.0 /-2GC	

VR x B.x (ATEX) Can be used on steel/cast iron filters up to Zone 1

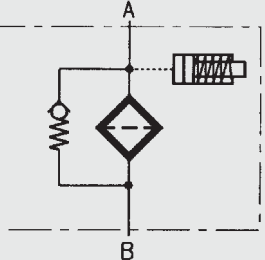
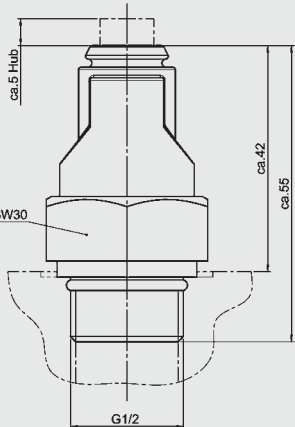
 	Type of indication	visual, red pin	
	Weight	44 g	
	Pressure setting or indication range	2 bar - 0.2 bar	
	Permitt. operating pressure	7 bar	
	Permitt. temperature range	-30 °C to +100 °C	
	Thread	G 1/2	
	Max. torque	15 Nm	
	Switching type	-	
	Max. switching voltage	-	
	Electrical connection	-	
	Max. switching voltage at resistive load	-	
	Switching capacity	-	
	Protection class to DIN 40050	-	
	Order example	VR 2 B.0 /-2GC-SO174	

VMF x C.x /-Ex2G

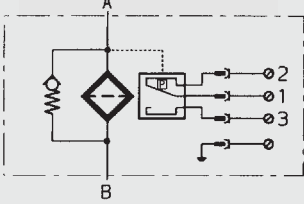
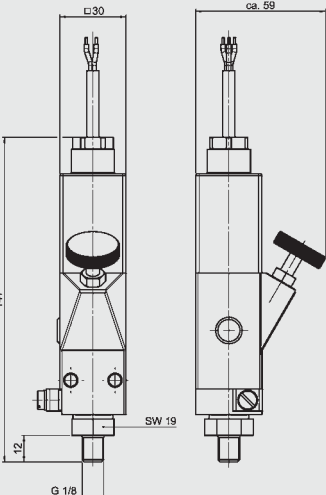
 	Type of indication	electrical switch	
	Weight	270 g	
	Pressure setting or indication range	2 bar ± 0.3 bar	
	Permitt. operating pressure	200 bar	
	Permitt. temperature range	-10 °C to +100 °C	
	Thread	G 1/8	
	Max. torque	15 Nm	
	Switching type	N/C or N/O (change-over contacts)	
	Max. switching voltage	250 V	
	Electrical connection	Cable connection PG 9 Cable length 2 m	
	Max. switching voltage at resistive load	62.5 W = 250 VA ~	
	Switching capacity	Ohmic 0.25 A at 250 V = Ohmic 1 A at 250 V ~	
	Protection class to DIN 40050	Ex II 2G EEx d IIC T6 / T5	
	Order example	VMF 2 C.0 /-Ex2G	

VR x C.x /-Ex2G

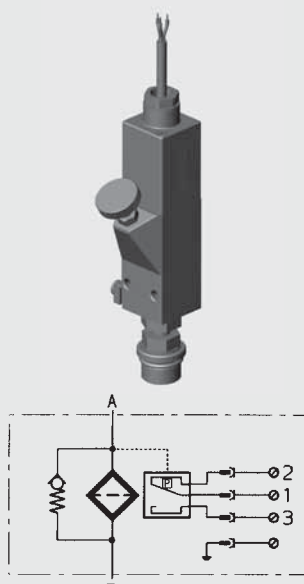
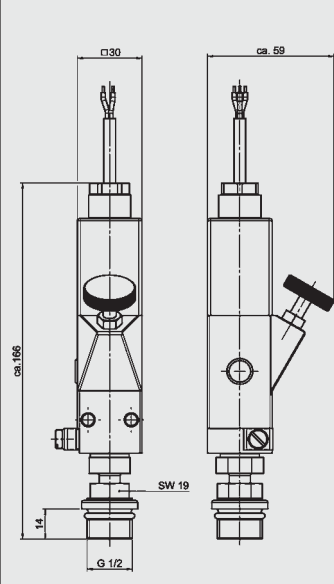
	Type of indication	electrical switch	
	Weight	340 g	
	Pressure setting or indication range	2 bar ± 0.3 bar	
	Permitt. operating pressure	40 bar	
	Permitt. temperature range	-10 °C to +100 °C	
	Thread	G 1/2	
	Max. torque	30 Nm	
	Switching type	N/C or N/O (change-over contacts)	
	Max. switching voltage	250 V	
	Electrical connection	Cable connection PG 9 Cable length 2 m	
	Max. switching voltage at resistive load	62.5 W = 250 VA ~	
	Switching capacity	Ohmic 0.25 A at 250 V = Ohmic 1 A at 250 V ~	
	Protection class to DIN 40050	Ex II 2G Ex d IIC T6 / T5	
Order example	VR 2 C.0 /-Ex2G		

VR x C.x (ATEX) Can be used on filters up to Zone 1 *

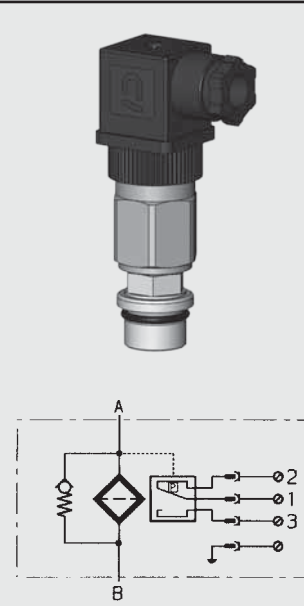
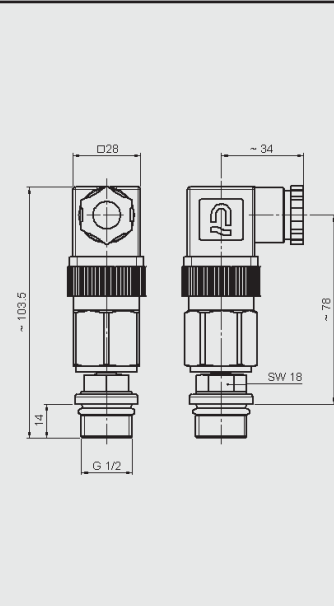
	Type of indication	electrical switch	
	Weight	340 g	
	Pressure setting or indication range	2 bar ± 0.3 bar	
	Permitt. operating pressure	40 bar	
	Permitt. temperature range	-30 °C to +100 °C	
	Thread	G 1/2	
	Max. torque	30 Nm	
	Switching type	N/C or N/O (change-over contacts)	
	Max. switching voltage	*	
	Electrical connection	Male connection M20 Female connector to DIN 43650	
	Max. switching voltage at resistive load	*	
	Switching capacity	*	
	Protection class to DIN 40050	IP 65 (only if the connector is wired and fitted correctly)	
Order example	VR 2 C.1 /-2GBC		

* The clogging indicator is simple electrical operating equipment according to DIN EN 60079-14 and may only be used in intrinsically safe circuits (supplied with manufacturer's declaration and operating instructions).

3.5.2 DIFFERENTIAL PRESSURE

VM x B.x (ATEX) Can be used on aluminium filters up to Zone 1

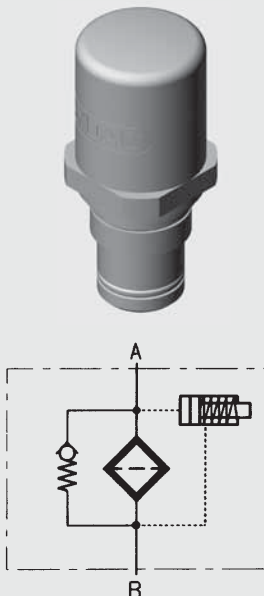
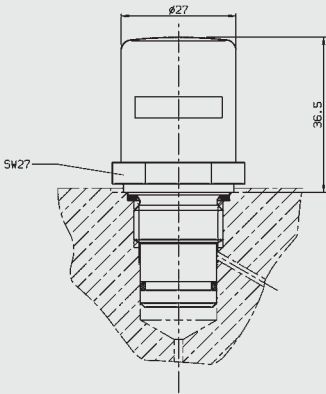
	Type of indication	Visual, red/green band Automatic reset	
	Weight	110 g	
	Pressure setting or indication range	5 bar - 10% 8 bar ± 10%	
	Permitt. operating pressure	210 bar	
	Permitt. temperature range	-30 °C to +100 °C	
	Thread	G 1/2	
	Max. torque value	33 Nm	
	Switching type	-	
	Max. switching voltage	-	
	Electrical connection	-	
	Max. switching voltage at resistive load	-	
	Switching capacity	-	
	Protection class to DIN 40050	-	
	Order example	VM 5 B.1 /-2GC	

VD x B.x (ATEX) Can be used on filters up to Zone 1

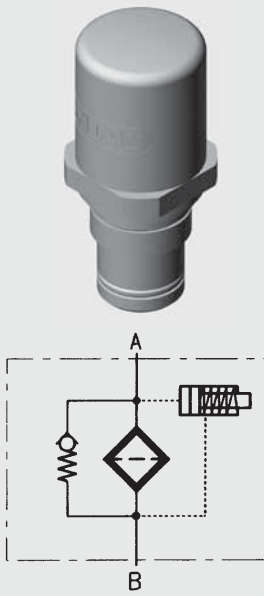
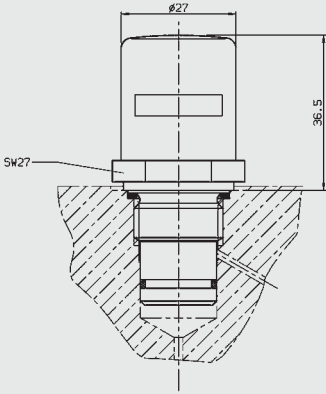
	Type of indication	Visual, red/green band Automatic reset	
	Weight	110 g	
	Pressure setting or indication range	5 bar - 10% 8 bar ± 10%	
	Permitt. operating pressure	420 bar	
	Permitt. temperature range	-30 °C to +100 °C	
	Thread	G 1/2	
	Max. torque value	100 Nm	
	Switching type	-	
	Max. switching voltage	-	
	Electrical connection	-	
	Max. switching voltage at resistive load	-	
	Switching capacity	-	
	Protection class to DIN 40050	-	
	Order example	VD 5 B.1 /-2GC	

VD x C.x /-2GEXDIIC

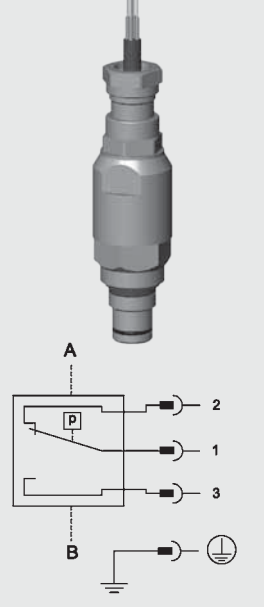
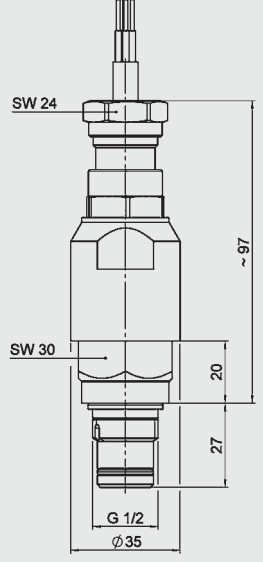
	Type of indication	electrical switch	
	Weight	from 600 g	
	Pressure setting or indication range	2 bar - 10% 5 bar - 10% 8 bar ± 10%	
	Permitt. operating pressure	420 bar	
	Permitt. temperature range	-20 °C to +60 °C	
	Thread	G 1/2	
	Max. torque value	100 Nm	
	Switching type	Change-over	
	Max. switching voltage	250 V	
	Electrical connection	Cable connection	
	Max. switching voltage at resistive load	60 W = 100 VA ~	
	Switching capacity	ohmic 3 A at 24 V = ohmic 0.03 A to 5 A at 250 V ~	
	Protection class to DIN 40050	IP 66	
	Order example	VD 2 C.1 /-2GEXDIIC	

VM x C.x (ATEX) Can be used on aluminium filters up to Zone 1 *

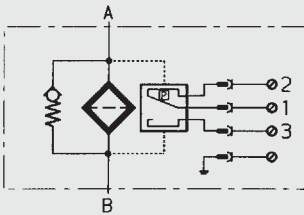
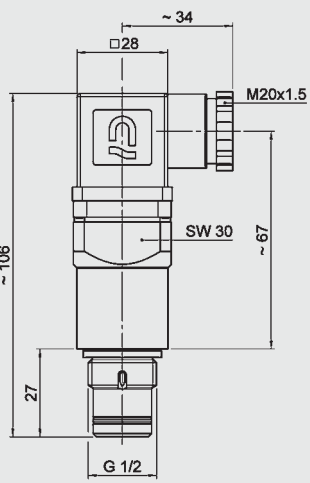
 	Type of indication	electrical switch	
	Weight	120 g	
	Pressure setting or indication range	2 bar - 10% 5 bar - 10% 8 bar ± 10%	
	Permitt. operating pressure	210 bar	
	Permitt. temperature range	-30 °C to +100 °C	
	Thread	G 1/2	
	Max. torque value	33 Nm	
	Switching type	N/C or N/O (change-over contacts)	
	Max. switching voltage	*	
	Electrical connection	Male connection M20 Female connector to DIN 43650	
	Max. switching voltage at resistive load	*	
	Switching capacity	*	
	Protection class to DIN 40050	IP 65 (only if the connector is wired and fitted correctly)	
Order example	VM 5 C.0 /-2GBC-SO135		

VD x C.x (ATEX) Can be used on filters up to Zone 1 *

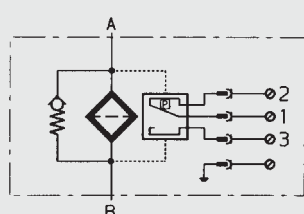
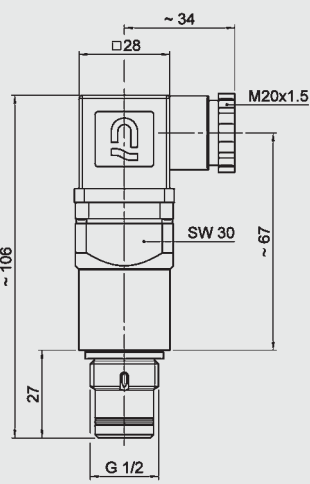
 	Type of indication	electrical switch	
	Weight	120 g	
	Pressure setting or indication range	2 bar - 10% 5 bar - 10% 8 bar ± 10%	
	Permitt. operating pressure	420 bar	
	Permitt. temperature range	-30 °C to +100 °C	
	Thread	G 1/2	
	Max. torque value	100 Nm	
	Switching type	N/C or N/O (change-over contacts)	
	Max. switching voltage	*	
	Electrical connection	Male connection M20 Female connector to DIN 43650	
	Max. switching voltage at resistive load	*	
	Switching capacity	*	
	Protection class to DIN 40050	IP 65 (only if the connector is wired and fitted correctly)	
Order example	VD 5 C.0 /-2GBC-SO135		

* The clogging indicator is simple electrical operating equipment according to DIN EN 60079-14 and may only be used in intrinsically safe circuits (supplied with manufacturer's declaration and operating instructions).

3.6 INDICATORS WITH UL OR CSA APPROVAL

3.6.1 DIFFERENTIAL PRESSURE

VM x C.x (UL)

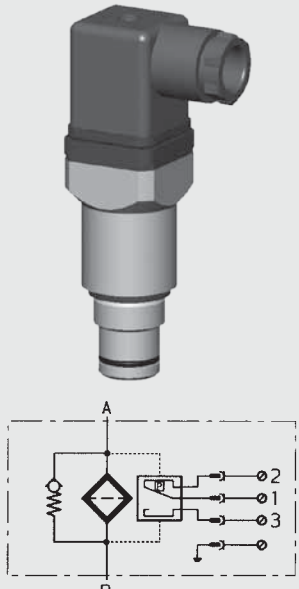
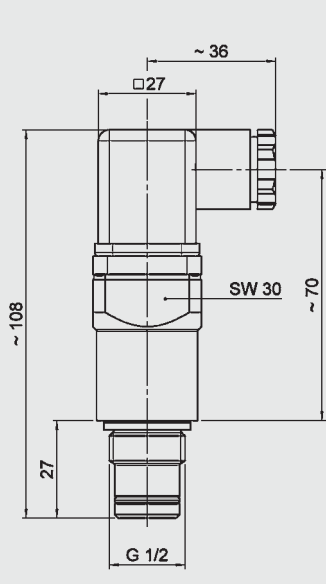
	Type of indication	electrical switch	
	Weight	120 g	
	Pressure setting or indication range	2 bar - 10% 5 bar - 10% 8 bar ± 10%	
	Permitt. operating pressure	210 bar	
	Permitt. temperature range	-30 °C to +100 °C	
	Thread	G 1/2	
	Max. torque value	33 Nm	
	Switching type	N/C or N/O (change-over contacts)	
	Max. switching voltage	115 V	
	Electrical connection	Male connection M20 Female connector to DIN 43650	
	Max. switching voltage at resistive load	60 W = 100 VA ~	
	Switching capacity	ohmic 3 A at 24 V =	
	Protection class to DIN 40050	IP 65 (only if the connector is wired and fitted correctly)	
	Order example	VM 5 C.0 /-CRUUS	

VD x C.x (UL)

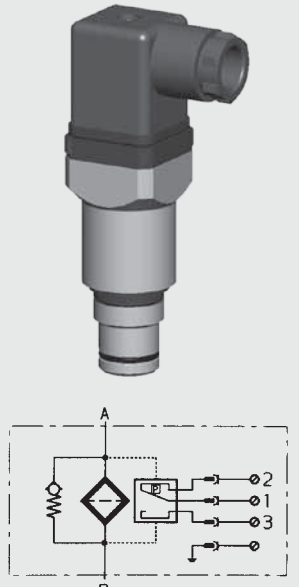
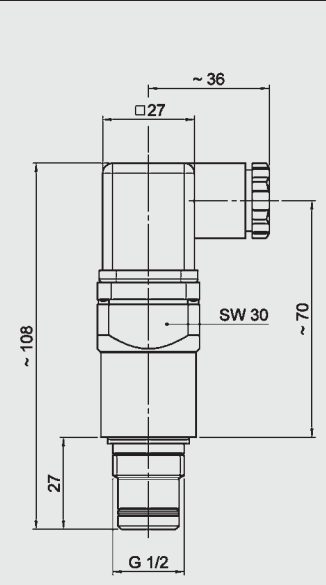
	Type of indication	electrical switch	
	Weight	120 g	
	Pressure setting or indication range	2 bar - 10% 5 bar - 10% 8 bar ± 10%	
	Permitt. operating pressure	420 bar	
	Permitt. temperature range	-30 °C to +100 °C	
	Thread	G 1/2	
	Max. torque value	100 Nm	
	Switching type	N/C or N/O (change-over contacts)	
	Max. switching voltage	115 V	
	Electrical connection	Male connection M20 Female connector to DIN 43650	
	Max. switching voltage at resistive load	60 W = 100 VA ~	
	Switching capacity	ohmic 3 A at 24 V =	
	Protection class to DIN 40050	IP 65 (only if the connector is wired and fitted correctly)	
	Order example	VD 5 C.0 /-CRUUS	

VM x D.x /-L... (UL)

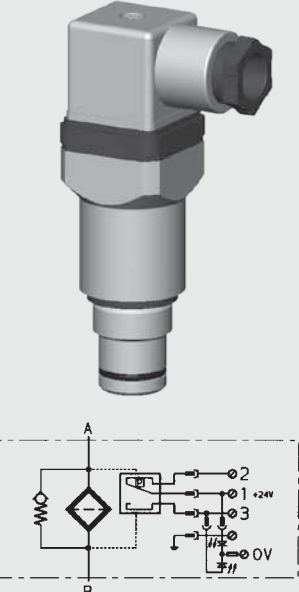
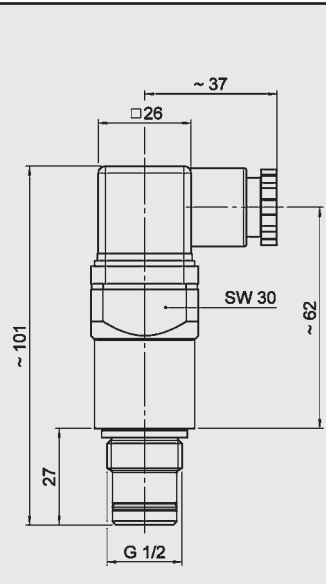
	Type of indication	visual indicator and electrical switch	
	Weight	150 g	
	Pressure setting or indication range	2 bar - 10% 5 bar - 10% 8 bar ± 10%	
	Permitt. operating pressure	210 bar	
	Permitt. temperature range	-30 °C to +100 °C	
	Thread	G 1/2	
	Max. torque value	33 Nm	
	Switching type	N/C or N/O (change-over contacts)	
	Max. switching voltage	24, 48, 110 V depending on the type of light insert	
	Electrical connection	Male connection M20 Female connector to DIN 43650	
	Max. switching voltage at resistive load	60 W = 100 VA ~	
	Switching capacity	ohmic 3 A at 24 V =	
	Protection class to DIN 40050	IP 65 (only if the connector is wired and fitted correctly)	
	Order example	VM 5 D.0 /-L24-CRUUS	

VD x D.x /-L... (UL)

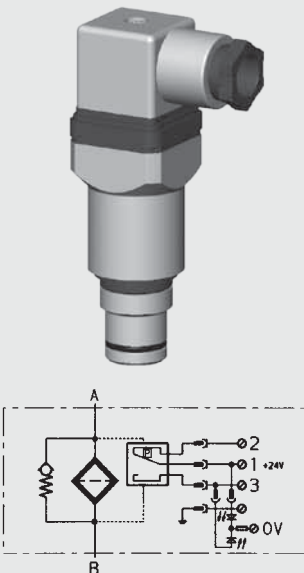
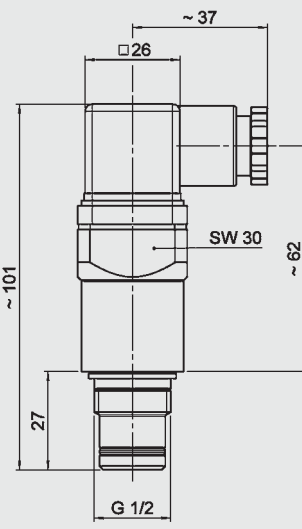
	Type of indication	visual indicator and electrical switch	
	Weight	250 g	
	Pressure setting or indication range	5 bar - 10% 8 bar ± 10%	
	Permitt. operating pressure	420 bar	
	Permitt. temperature range	-30 °C to +100 °C	
	Thread	G 1/2	
	Max. torque value	100 Nm	
	Switching type	N/C or N/O (change-over contacts)	
	Max. switching voltage	24, 48, 110 V depending on the type of light insert	
	Electrical connection	Male connection M20 Female connector to DIN 43650	
	Max. switching voltage at resistive load	60 W = 100 VA ~	
	Switching capacity	ohmic 3 A at 24 V =	
	Protection class to DIN 40050	IP 65 (only if the connector is wired and fitted correctly)	
Order example	VD 5 D.0 /-L24-CRUUS		

3.6.2 RETURN LINE

VR x C.x (CSA)

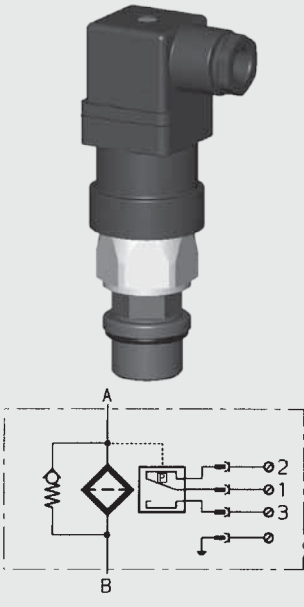
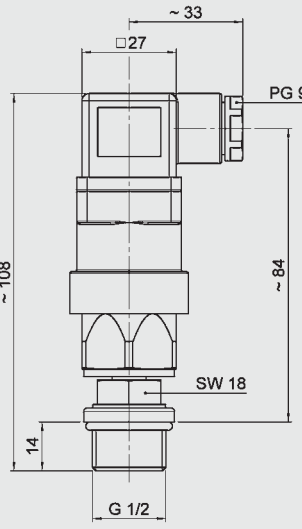
	Type of indication	electrical switch	
	Weight	340 g	
	Pressure setting or indication range	2 bar – 0.3 bar	
	Permitt. operating pressure	40 bar	
	Permitt. temperature range	-30 °C to +100 °C	
	Thread	G 1/2	
	Max. torque value	30 Nm	
	Switching type	N/C or N/O, (change-over contacts)	
	Max. switching voltage	230 V	
	Electrical connection	Male connection PG 9 Female connector to DIN 43650	
	Max. switching voltage at resistive load	250 W = 300 VA ~	
	Switching capacity	ohmic 4 A at 24 V ohmic 0.3 to 4 A at max. 230 V ~	
	Protection class to DIN 40050	IP 65 (only if the connector is wired and fitted correctly)	
Order example	VR 2 C.0 /-CSA		

4. MODEL CODE

VR 2 D . X /-V-L24

4.1 STANDARD CLOGGING INDICATORS

Typ

- VMF return line indicator; connection G 1/8
- VR return line indicator; connection G 1/2
- VRD return line indicator; for differential pressure cavity
- VM differential pressure indicator; up to 210 bar operating pressure
- VD differential pressure indicator; up to 420 bar operating pressure
- VL differential pressure indicator; up to 25 bar operating pressure
- V02 differential pressure indicator; piped separately; up to 160 bar operating pressure

Pressure setting

see particular clogging indicator

Type

- B visual with automatic reset
- BF visual, mobile
- BM visual with manual reset
- C electrical
- CA electrical with AMP plug (Mark II)
- CD electrical with Deutsch plug (DT 04-2P)
- CJ electrical with Junior Power Timer
- CM electrical with M12x1 plug
- D visual/electrical
- E pressure gauge, horizontal
- ES pressure gauge, vertical
- F pressure switch
- FD pressure switch with Deutsch plug (DT 04-2P)
- GC electronic
- GW electronic
- H pressure switch
- K pressure gauge, horizontal
- LE visual-mechanical indicator with 100% switching contact
- LEM visual-mechanical indicator with 100% switching contact and M12x1 plug
- LZ visual mechanical with 75% and 100% switching contact
- M electrical, ground switching
- R pressure gauge, horizontal
- UBM visual, vacuum
- UE vacuum pressure gauge, horizontal
- UF vacuum switch
- V visual/analogue
- VE visual/analogue with 100% switching contact
- VZ visual/analogue with 75% and 100% switching contact

Modification number

- X the latest version is always supplied

Supplementary details

- 30C cold start suppression of switching outputs up to 30 °C ±5 °C
(only for C, D, LZ indicators; DC voltage supply only – max. 24 Volt;
C and D indicators only for VD and VM; on D and LZ indicators, contacts must be wired N/O only)
- L... light with corresponding voltage (24, 48, 110, 230 Volt)] only for
LED 2 LEDs up to 24 Volt] type "D"
- OE N/C function
- SO135 indicator suitable for PLC controls due to Gold-Crosspoint contacts
- W suitable for oil/water emulsions (HFA, HFC)
- V seal in Viton (FPM), suitable for phosphate esters (HFD-R) and biodegradable oils
(**must be specified for type "GW"**)

Supplementary details for "GC" type

- 113 N/O function pressure peak suppression up to 10 sec.
cold start suppression of switching outputs
(PNP technique, positive switching) up to 25 °C] **Must be specified!**
Others on request
- 123 N/C function pressure peak suppression up to 10 sec.
cold start suppression of switching outputs
(PNP technique positive switching) up to 25 °C]
- 30C cold start suppression of switching outputs up to 30 °C (other temperatures on request)
- LED 3 LED's (green, yellow, red) in terminal box
- PF floating switching outputs (due to relay in the plug)
- SP analogue signal: voltage output 1-10 V] if SP or SQ are not specified
SQ analogue signal: voltage output 4...20 mA (current source)] "current sink" model supplied

Supplementary details for "GW" type

- 113 N/O function pressure peak suppression up to 10 sec.
cold start suppression of switching outputs
(PNP technique, positive switching) up to 25 °C] **Must be specified!**
Others on request
- 123 N/C function pressure peak suppression up to 10 sec.
cold start suppression of switching outputs
(PNP technique positive switching) up to 25 °C]

Supplementary details for "LZ" type

- AV plug and connector to AUDI, VW specification
- BO plug and connector to BMW, Opel, Ford specification
- BO-LEDas for BO, but with progressive LED strip
- CN electrical connection, 1 connector DIN 43651 with 3 LEDs (to CNOMO specification NF E 48-700)
- DB electrical connection, 1 connector to DIN 43651 with 3 LEDs (to Daimler-Benz and BMW specification)
- D4C plug and connector to Daimler-Chrysler specification with cold start suppression 30 °C

Supplementary details to "ATEX" type







- 2GC for visual indicator type "B" with ATEX certificate
- 2GBC for electrical indicator type "C" with ATEX certificate (the switch used in the indicator is a passive component according to EN 50020 and can therefore be used in intrinsically safe circuits as simple apparatus in accordance with EN 60079-14)
- 2GEXDIIC for electrical indicator suitable for use in Zone 1 (Category 2), gas atmosphere, Category d (Flameproof Enclosure), Explosive subdivision IIC to ATEX directive
- EX2G Ex-protection type for the return line indicator type "C"

Supplementary details for "UL" and "CSA" approval

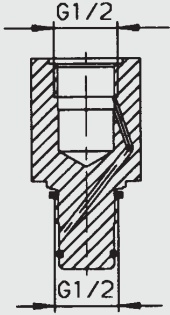
- CRUUS for electrical differential indicator type "C" or visual/electrical indicator type "D" with UL approval
- CSA for electrical return line indicator type "C" with CSA approval

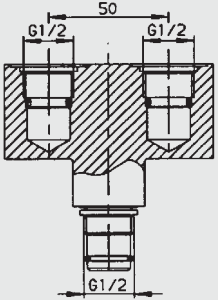
5. ADAPTERS

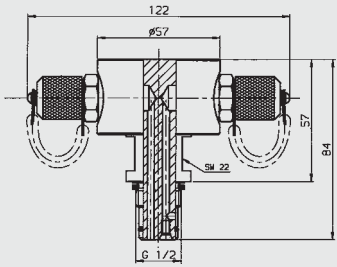
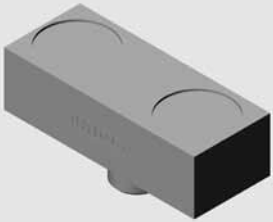
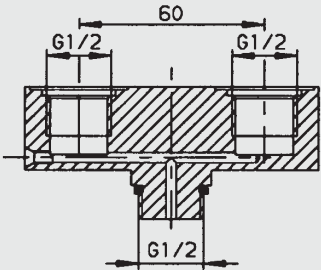
5.1 TYPES

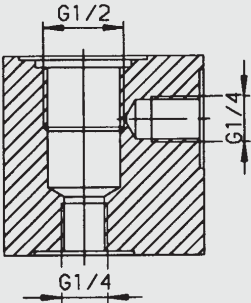
	<table border="1"> <tr> <td>Designation</td> <td>ADAPTER VD-D-S.0</td> </tr> <tr> <td>Part no.</td> <td>00318736</td> </tr> <tr> <td>Description</td> <td>Extending adapter for differential pressure cavity to HYDAC works standard HN 28-22</td> </tr> </table>	Designation	ADAPTER VD-D-S.0	Part no.	00318736	Description	Extending adapter for differential pressure cavity to HYDAC works standard HN 28-22	
Designation	ADAPTER VD-D-S.0							
Part no.	00318736							
Description	Extending adapter for differential pressure cavity to HYDAC works standard HN 28-22							
	<table border="1"> <tr> <td>Designation</td> <td>ADAPTER VD-D+D-S+S.0</td> </tr> <tr> <td>Part no.</td> <td>00318732</td> </tr> <tr> <td>Description</td> <td>Y-adapter to convert 1 differential pressure cavity into 2 differential pressure cavities according to HYDAC works standard HN 28-22. Swivel-type on request!</td> </tr> </table>	Designation	ADAPTER VD-D+D-S+S.0	Part no.	00318732	Description	Y-adapter to convert 1 differential pressure cavity into 2 differential pressure cavities according to HYDAC works standard HN 28-22. Swivel-type on request!	
Designation	ADAPTER VD-D+D-S+S.0							
Part no.	00318732							
Description	Y-adapter to convert 1 differential pressure cavity into 2 differential pressure cavities according to HYDAC works standard HN 28-22. Swivel-type on request!							
	<table border="1"> <tr> <td>Designation</td> <td>ADAPTER VD-1/4+1/4-W+W.0 /-00404337</td> </tr> <tr> <td>Part no.</td> <td>00404337</td> </tr> <tr> <td>Description</td> <td>Test adapter for different pressure cavity according to HYDAC works standard HN 28-22. To test the pressure before and after the filter element. Also available without minimess couplings (on request)!</td> </tr> </table>	Designation	ADAPTER VD-1/4+1/4-W+W.0 /-00404337	Part no.	00404337	Description	Test adapter for different pressure cavity according to HYDAC works standard HN 28-22. To test the pressure before and after the filter element. Also available without minimess couplings (on request)!	
Designation	ADAPTER VD-1/4+1/4-W+W.0 /-00404337							
Part no.	00404337							
Description	Test adapter for different pressure cavity according to HYDAC works standard HN 28-22. To test the pressure before and after the filter element. Also available without minimess couplings (on request)!							
	<table border="1"> <tr> <td>Designation</td> <td>ADAPTER VR-R+R-S+S.0</td> </tr> <tr> <td>Part no.</td> <td>00318741</td> </tr> <tr> <td>Description</td> <td>Y-adapter to convert 1 return line cavity into 2 return line cavities (G 1/2) Swivel-type on request!</td> </tr> </table>	Designation	ADAPTER VR-R+R-S+S.0	Part no.	00318741	Description	Y-adapter to convert 1 return line cavity into 2 return line cavities (G 1/2) Swivel-type on request!	
Designation	ADAPTER VR-R+R-S+S.0							
Part no.	00318741							
Description	Y-adapter to convert 1 return line cavity into 2 return line cavities (G 1/2) Swivel-type on request!							
	<table border="1"> <tr> <td>Designation</td> <td>ADAPTER V 1/4 I-D-S.0</td> </tr> <tr> <td>Part no.</td> <td>00318730</td> </tr> <tr> <td>Description</td> <td>Connection adapter for piping clogging indicators separately with differential pressure cavity according to HYDAC works standard HN 28-22. Two connections G 1/4 (one before and one after the filter element)</td> </tr> </table>	Designation	ADAPTER V 1/4 I-D-S.0	Part no.	00318730	Description	Connection adapter for piping clogging indicators separately with differential pressure cavity according to HYDAC works standard HN 28-22. Two connections G 1/4 (one before and one after the filter element)	
Designation	ADAPTER V 1/4 I-D-S.0							
Part no.	00318730							
Description	Connection adapter for piping clogging indicators separately with differential pressure cavity according to HYDAC works standard HN 28-22. Two connections G 1/4 (one before and one after the filter element)							

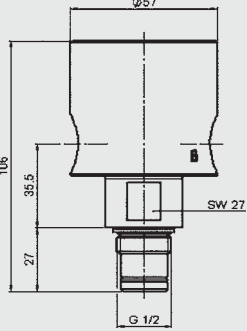
	Designation	ADAPTER VD-D+1/4+1/4-S+W+W.0	
	Part no.	00318744	
	Description	Extending adapter for differential pressure cavity according to HYDAC works standard HN 28-22. Also two connections, one before and one after the filter element.	

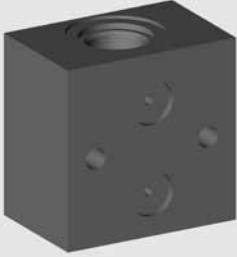
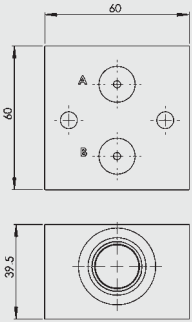
	Designation	ADAPTER VF-D-S.0 /-RT	
	Part no.	On request	
	Description	only for the following filters: LFR, LPFR, MDFR, RFLR, RFMR, RKMR, SFFR	

5.2 MODEL CODEL (= EXAMPLE)

ADAPTER VD-D+1/4+1/4-S+W+W.X /-ESB

Connection

- VD differential pressure indicator; connection G 1/2
- VR return line indicator; connection G 1/2
- V1/4 differential pressure indicator; connection G 1/4 internal
- VF differential pressure indicator; flange type

Ports (several ports are possible!)

- D differential pressure cavity G 1/2
- R return line cavity G 1/2
- MF cavity for pressure gauge and pressure switch
- 1/4 cavity G 1/4 for Minimes test points (M16 x 1.5)
- 1/8 cavity G 1/8 for Minimes test points (plug-in connection)

Orientation of the ports

- S vertical
- W horizontal

Type code

- X the latest version is always supplied

Supplementary details

- ESB swivel type
- V seal in Viton (FPM), suitable for phosphate ester (HFD-R) and biodegradable oils

VD-D+1/4+1/4-S+W+W.0

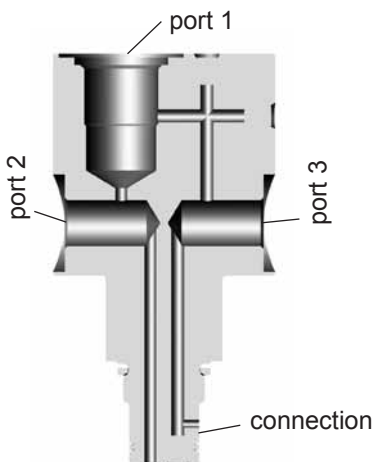

5.3 OTHER EXAMPLES

VD-D-S.0

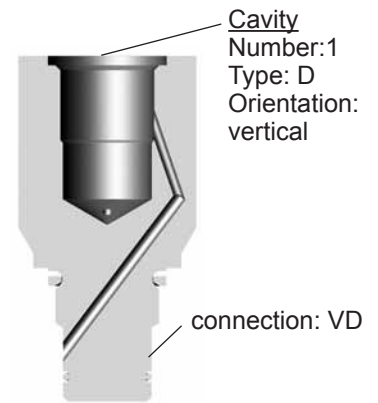

VR-R+R-S+S.0

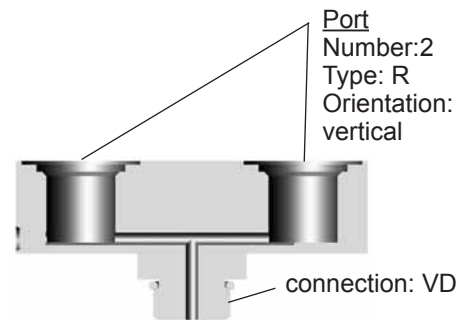

6. DESINA SPECIFICATION

DESINA is a fully comprehensive system intended to bring standardization and decentralization to the field of fluid technology and to electrical installation of machinery and systems. The system engineering, automotive and supply industries have worked together to draw up specifications of the necessary components. DESINA makes use of tried-and-tested solutions, such as open bus systems, standard industrial plugs etc.

By standardizing components, interfaces and connection systems, such as a hybrid field bus cable (Cu/LWL), a wide range of different field bus systems can be made compatible on a single physical base.

6.1. TOTAL CONCEPT FOR MACHINE TOOL INSTALLATION

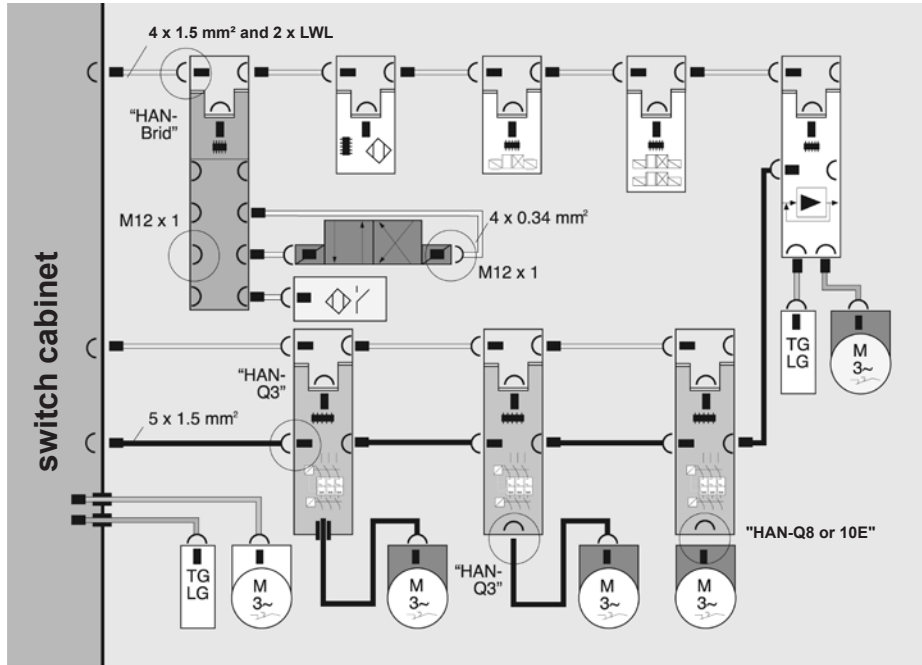

6.2. CLOGGING INDICATORS

The following clogging indicators are approved to DESINA specification:

- VD 5 LZ.1 /-D4C
- VR 2.5 LZ. 1 /-D4C
- VD 5 LZ.1 /-BO
- VR 2.5 LZ. 1 /-BO
- VD 5 LZ. 1 /-AV
- VR 2.5 LZ. 1 /-AV
- VR 2.5 LZ. 0 /-GM

all with M 12 x 1 connector!



DESINA

The DESINA logo is shown on the type code label of approved clogging indicators.

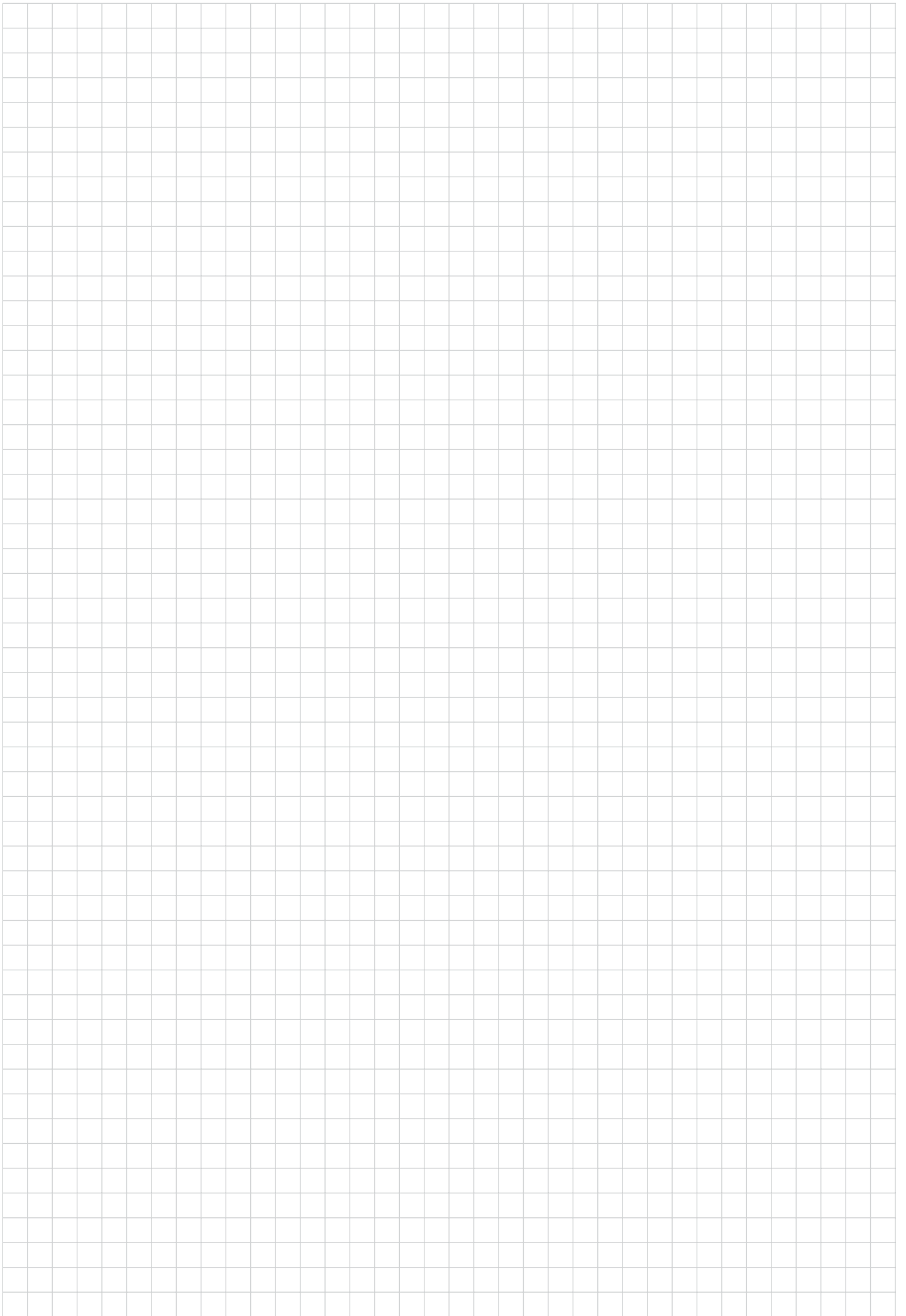

NOTE

The information in this brochure relates to the operating conditions and applications described.

For applications or operating conditions not described, please contact the relevant technical department.

Subject to technical modifications.

HYDAC FILTERTECHNIK GMBH

Industriegebiet

D-66280 Sulzbach/Saar

Tel.: 0 68 97 / 509-01

Fax: 0 68 97 / 509-300

Internet: www.hydac.com

E-Mail: filter@hydac.com